



# Victoria Government Gazette

By Authority of Victorian Government Printer

**No. G 15 Thursday 16 April 2015**

[www.gazette.vic.gov.au](http://www.gazette.vic.gov.au)

**GENERAL**

---

**TABLE OF PROVISIONS**

---

Private Advertisements		Sales by the Sheriff	
Dissolution of Partnership		Andrew Karl Knorr	777
VELUDOMUSIC	774	James William Vos	778
Estates of Deceased Persons		Government and Outer Budget Sector	
A. B. Natoli Pty	774	Agencies Notices	779
Alan Wainwright J. Okno & Co.	774	Orders in Council	803
Basile & Co. Pty Ltd	744	Acts: Crown Land;	
Bruce M. Cook & Associates	774	Local Government;	
Ellinghaus Weill	774	Rural Finance;	
Hicks Oakley Chessell Williams	774	State Owned Enterprises	
Ingpen & Bent	775		
John Boundy	775		
Lorraine Jones & Associates	775		
Macpherson + Kelley	775		
Parke Lawyers Pty Ltd	775		
Perpetual Legal Services Pty Ltd	776		
Pietrzak Solicitors	776		
Rennick & Gaynor	776		
Rowson Brasse & Co.	776		
Slater & Gordon	776		
Susan Elizabeth Bennett	776		
Taits Legal	776		
Tivey & Holland	777		
Tony O'Brien Legal	777		
Tucker Partners	777		
White Cleland Pty	777		
Wollerman Shacklock Lawyers	777		

---

**Advertisers Please Note**

As from 16 April 2015

The last Special Gazette was No. 82 dated 14 April 2015

The last Periodical Gazette was No. 1 dated 18 June 2014.

---



---

**How To Submit Copy**

- See our webpage [www.gazette.vic.gov.au](http://www.gazette.vic.gov.au)
  - or contact our office on 8523 4601  
between 8.30 am and 5.30 pm Monday to Friday
-

**PUBLICATION OF THE VICTORIA GOVERNMENT GAZETTE (General)  
ANZAC DAY WEEK 2015 (Saturday 25 April 2015)**

**Please Note Deadlines for General Gazette G17/15:**

The Victoria Government Gazette (General) for ANZAC week (G17/15) will be published on **Thursday 30 April 2015**.

**Copy deadlines:**

Private Advertisements **9.30 am on Monday 27 April 2015**

Government and Outer

Budget Sector Agencies Notices **9.30 am on Tuesday 28 April 2015**

**Office Hours:**

The Victoria Government Gazette Office is open during normal office hours over the holiday period, i.e. 8.30 am to 5.30 pm Monday to Friday, excluding public holidays.

Where urgent gazettal is required after hours, arrangements should be made with the Government Gazette Officer on 0419 327 321.

JENNY NOAKES  
Government Gazette Officer

---

## PRIVATE ADVERTISEMENTS

### DISSOLUTION OF PARTNERSHIP

Notice is hereby given that the partnership between Gabriel Vargas, Leslie Stuart and Jason Millar, which traded under the name of VELUDOMUSIC (ABN 80 270 412 415), has been dissolved with effect from 18 February 2015. Henceforth, it has been agreed by all parties that Gabriel Vargas can retain use of the business name VELUDOMUSIC, and therefore has permission from all parties to transfer and operate the business name VELUDOMUSIC under his own personal ABN (11 077 633 563).

Re: ELLEN MARY CODY, late of 3/18 Head Street, Balwyn, Victoria, home duties, deceased.

Creditors, next-of-kin and others having claims in respect of the estate of the deceased, who died on 30 December 2014, are required by the trustee, Paul Michael Cody, to send particulars to the trustee, care of the undermentioned solicitors, by a date not later than two months from the date of publication thereof, after which date the trustee may convey or distribute the assets, having regard only to the claims of which he has notice.

A. B. NATOLI PTY, solicitors,  
24 Cotham Street, Kew 3101.

Re: DENISE DOROTHEA GOODMAN (also known as Denise Dorothea Boughton), late of 45 Grange Road, Alphington, Victoria, solicitor, deceased.

Creditors, next-of-kin and all others having claims in respect of the estate of the deceased, who died on 29 February 2008, are required by the executor, Richard Neish Boughton of 45 Grange Road, Alphington, Victoria, to send particulars of such claims to the said executor by 16 July 2015, after which date the executor will distribute the assets, having regard only to the claims of which he has notice.

ALAN WAINWRIGHT J. OKNO & CO.,  
lawyers,  
3/170 Queen Street, Melbourne 3000.

Re: Estate BERNICE HELEN BEILBY, deceased.

In the estate of BERNICE HELEN BEILBY, late of Sea Lake Nursing Home, McClelland Avenue, Sea Lake, Victoria, widow, deceased. Creditors, next-of-kin and others having claims against the estate of the said deceased are

required by Lesley Joan Lloyd and Rowlene Joy Pascoe (in the Will called Rowlene Joy McConnell), the executors of the Will of the said deceased, to send particulars of such claims to them, care of the undermentioned solicitors, within two months from the date of publication of this notice, after which date they will distribute the assets, having regard only to the claims of which they then have notice.

BASILE & CO. PTY LTD, legal practitioners,  
46 Wellington Street, Kerang, Victoria 3579.

Re: MARIA MAGDOLNA MEZEI, deceased.

Creditors, next-of-kin and others having claims in respect of the estate of MARIA MAGDOLNA MEZEI, late of 1 New Street, Hawthorn, Victoria, who died on 3 January 2015, are to send particulars of their claims to the personal representative/s, care of the undermentioned solicitors, by 17 June 2015, after which date the personal representative/s may convey or distribute the assets, having regard only to the claims of which they then have notice.

BRUCE M. COOK & ASSOCIATES,  
solicitors,  
Level 4, 114 William Street, Melbourne 3000.

GARY JOHN READ, late of Joan Pinder Nursing Home, 26 Gibson Street, Bendigo, Victoria, deceased.

Creditors, next-of-kin and others having claims in respect of the estate of the deceased, who died on 14 January 2015, are required by the personal representative, Armin Edmund Ellinghaus, to send particulars to him, care of the undermentioned solicitors, by 30 June 2015, after which date the personal representative may convey or distribute the assets, having regard only to the claims of which he then has notice.

ELLINGHAUS WEILL, solicitors,  
79–81 Franklin Street, Melbourne, Victoria 3000.

Re: Estate LORNA JEAN MARKS.

Creditors, next-of-kin and others having claims against the estate of LORNA JEAN MARKS, late of Unit 8, 55 Walpole Street, Kew, Victoria, widow, deceased, who died on 8 December 2014,

are requested to send particulars of their claims to the executor, care of the undermentioned solicitors, by Friday 19 June 2015, after which date he will distribute the assets, having regard only to the claims of which he then has notice.

HICKS OAKLEY CHESSELL WILLIAMS,  
solicitors,  
13/379 Collins Street, Melbourne 3000.

---

JOSEPH LOSONCZ, late of Uniting Aged Care – Kalkee Nangatta, 206 High Street, Belmont, retired, deceased.

Creditors, next-of-kin and others having claims in respect of the estate of the abovenamed deceased, who died on 27 February 2015, are required by the trustee, Giselle Kutty, to send particulars of their claims to the trustee, care of the undermentioned legal practitioners, by 10 July 2015, after which date the trustee may convey or distribute the assets, having regard only to the claims of which she then has notice.

INGPEN & BENT, legal practitioners,  
legal practitioners for the trustee,  
95 Yarra Street, Geelong 3220.

---

JOHN GILBERT BOND, late of 15 Swan Street, Bendigo 3550, deceased.

Creditors, next-of-kin and others having claims in respect of the estate of the deceased, who died on 3 January 2015, are required by the trustee, John Boundy of 92 Wills Street, Bendigo, Victoria, solicitor, to send particulars to the trustee by 19 June 2015, after which date the trustee may convey or distribute the assets, having regard only to the claims of which the trustee has notice.

JOHN BOUNDY, solicitor,  
92 Wills Street, Bendigo 3550.

---

Re: PHYLLIS EDNA BUCKINGHAM,  
deceased.

Creditors, next-of-kin and others having claims in respect of the estate of the deceased, who died on 3 July 2014, are required by the trustees, Robert George Buckingham of 900 Main Road, Eltham, Victoria, consultant, and and Lorraine Kaye Conway of 900 Main Road, Eltham, Victoria, secretary, to send particulars to the trustees by 12 June 2015, after which date

the trustees may convey or distribute the assets, having regard only to the claims of which the trustees have notice.

LORRAINE JONES & ASSOCIATES,  
solicitors,  
900 Main Road, Eltham 3095.

---

Re: MARK CLEMENT HONE, late of 30 Shaftsbury Drive, Mulgrave, Victoria, engineer, deceased.

Creditors, next-of-kin and others having claims in respect of the estate of the deceased, who died on 24 October 2013, are required by the trustee, Trevor Shane Hone, care of 40–42 Scott Street, Dandenong, Victoria 3175, to send particulars to the trustee by 15 June 2015, after which date the trustee may convey or distribute the assets, having regard only to the claims of which the trustee has notice.

MACPHERSON + KELLEY LAWYERS,  
40–42 Scott Street, Dandenong 3175.

---

Re: ELLEN ELIZABETH O'BRIEN, late of Cabrini Residential Care, 54 Queens Parade, Ashwood, Victoria, nun, deceased.

Creditors, next-of-kin and others having claims in respect of the estate of the deceased, who died on 21 August 2014, are required by the trustees, Judith Cecilia Bramich and Michael John Guiney, care of 40–42 Scott Street, Dandenong, Victoria 3175, to send particulars to the trustees by 15 June 2015, after which date the trustees may convey or distribute the assets, having regard only to the claims of which the trustees have notice.

MACPHERSON + KELLEY, lawyers,  
40–42 Scott Street, Dandenong 3175.

---

DOROTHY LESLY CAPPER, late of Unit 9, 62 Cavanagh Street, Cheltenham, Victoria, retired, deceased.

Creditors, next-of-kin and others having claims in respect of the estate of the deceased, who died on 15 July 2013, are required by the trustees, Margaret Fay Hazelwood and Barbara Ann Gray, to send particulars to them, care of the undermentioned solicitors, by 16 June 2015, after which date the trustees may convey or distribute the assets, having regard only to the claims of which they then have notice.

PARKE LAWYERS PTY LTD,  
Level 1, 35 Seymour Street, Ringwood,  
Victoria 3134.

---

JACQUELINE MARY COLE, late of 2 Mackie Grove, Brighton East, Victoria, retired nurse, deceased.

Creditors, next-of-kin and others having claims in respect of the estate of the deceased, who died on 20 October 2014, are required by Perpetual Trustee Company Limited, ACN 000 000 007 of 35/525 Collins Street, Melbourne, Victoria, the executor, to send particulars to it by 25 June 2015, after which date it may convey or distribute the assets, having regard only to the claims of which it then has notice.

PERPETUAL LEGAL SERVICES PTY LTD,  
35/525 Collins Street, Melbourne, Victoria 3000.

Creditors, next-of-kin and others having claims in respect of the estate of ANDREW JOHN WILSON, late of 55 The Terrace, Ocean Grove, Victoria, deceased, who died on 28 January 2015, are required to send particulars of such claims to the executor, care of the undermentioned solicitors, by 15 June 2015, after which date the executor will convey or distribute the assets, having regard only to the claims of which the executor then has notice.

PIETRZAK SOLICITORS,  
222 LaTrobe Street, Melbourne 3000.

GLORIA JUNE SANDERS, late of The Heights, 39–41 Mitcham Road, Donvale, Victoria, retired, deceased.

Creditors, next-of-kin and others having claims in respect of the estate of the abovenamed deceased, who died on 9 November 2014, are required by the executors, Toni Whyte, of 2 Hammett Place, Spence, Australian Capital Territory, and Geoffrey James Stephenson, of Unit 5, 51 Disraeli Street, Kew, Victoria, to send particulars of their claims to them (care of the undersigned) by 16 June 2015, after which date they may convey or distribute the assets, having regard only to the claims of which they then have notice.

RENNICK & GAYNOR, solicitors,  
431 Riversdale Road, Hawthorn East,  
Victoria 3123.

Re: FRANCIS HENRY REEDY, deceased.

Creditors, next-of-kin and others having claims in respect of the estate of the deceased, FRANCIS HENRY REEDY, who died on 5

November 2014, are required by the trustee, Jillian Edith Cooper, to send particulars to the trustee, care of the undermentioned solicitors, by 31 May 2015, after which date the trustee may convey or distribute the assets, having regard only to the claims of which the trustee has notice.

ROWSON BRASSE & CO., solicitors,  
Suite 2, 37 Princes Highway, Dandenong,  
Victoria 3175.

STANISLAWA PROCAK, late of Florence Aged Care, 375–379 Mason Street, Altona North, deceased.

Creditors, next-of-kin and others having claims in respect of the estate of the deceased, who died on 18 November 2013, are required by the personal legal representative, Eugeniusz Procak, to send particulars to him, care of the undermentioned solicitors, by 9 June 2015, after which date the personal representative may convey or distribute the assets, having regard only to the claims of which he then has notice.

SLATER & GORDON, solicitors,  
100 Paisley Street, Footscray, Victoria 3011.

LORNA EMILY BENNETT, late of 55 Walpole Street, Kew, accountant.

Creditors, next-of-kin and all others having claims in respect of the estate of the deceased, who died on 21 September 2014, are required by the executor, Susan Elizabeth Bennett of 5 Madden Grove, Kew, Victoria 3101, to send particulars of such claims to the said executor by 23 June 2015, after which date the executor will distribute the assets, having regard only to the claims of which she has notice.

Re: KEVIN GERRARD LAFRANCHI, late of 12 Hyland Street, Warrnambool, Victoria, deceased.

Creditors, next-of-kin and others having claims in respect of the estate of the deceased, who died on 25 June 2014, are required by the executor/personal representative to send particulars to her, care of the undermentioned solicitors, by 16 June 2015, after which date she may convey or distribute the assets, having regard only to the claims of which she then has notice.

TAITS LEGAL,  
121 Kepler Street, Warrnambool 3280.

Re: WILLIAM JOHN O'KEEFFE, late of 6/49 Cramer Street, Warrnambool, deceased.

Creditors, next-of-kin and others having claims in respect of the estate of the deceased, who died on 11 January 2014, are required by the personal representatives to send particulars to them, care of the undermentioned solicitors, by 17 June 2015, after which date they may convey or distribute the assets, having regard only to the claims of which they then have notice.

TAITS LEGAL,  
121 Kepler Street, Warrnambool 3280.

---

FLORENCE DOREEN YOUNG, late of Ararat Retirement Village, 26a Princes Street, Ararat, Victoria, deceased.

Creditors, next-of-kin and others having claims in respect of the estate of the deceased, who died on 8 October 2014, are required by the executors, Georgina Florence Bibby and Henry George Young, care of the undermentioned solicitors, to send particulars to them by 15 June 2015, after which date the executors may convey or distribute the assets, having regard only to the claims of which they then have notice.

TIVEY & HOLLAND, solicitors,  
97 Barkly Street, Ararat 3377.

---

Re: JEANNIE ANNETTE SUMMERS, late of Unit 5, 4-42 Coral Drive, Hampton Park, Victoria, retired gentlewoman, deceased.

Creditors, next-of-kin and others having claims in respect of the estate of the deceased, who died on 4 April 2012, are required to send particulars of their claims to the executor, Andrew Colin Dignam, care of 46 Forest Road, Ferntree Gully, on or before 16 June 2015, after which date the executor may convey or distribute the assets, having regard only to the claims of which he then has notice.

TONY O'BRIEN LEGAL, lawyers,  
46 Forest Road, Ferntree Gully 3156.

---

Re: JOHN LESLIE ROOK, late of 10 Greendale Road, Glen Iris 3146.

Creditors, next-of-kin and others having claims in respect of the estate of the deceased, who died on 11 January 2015, are required by the executor, Adam John Rook, to send particulars

of their claim to him, care of the undermentioned solicitors, by 16 June 2015, after which date the said executor may convey or distribute the assets, having regard only to the claims of which he then has notice.

TUCKER PARTNERS,  
Level 34, 360 Collins Street, Melbourne 3000.

---

Re: WALTER SAM GALE (also known as Walter Samuel Gale), deceased.

Creditors, next-of-kin and others having claims in respect of the estate of the deceased, who died on 18 November 2014, are required by the trustees, Neal Walter Gale, Clifford Owen Gale and Christine Marjorie Branson (also known as Tina Gale), to send particulars to the trustees, care of the undermentioned solicitors, by 16 June 2015, after which date the trustees may convey or distribute the assets, having regard only to the claims of which the trustees have notice.

WHITE CLELAND PTY., solicitors,  
Level 3, 454 Nepean Highway, Frankston 3199.  
- Ref. LH.

---

BRUCE DONALD HENDERSON, late of 31 Mabel Crescent, Mount Macedon, Victoria, deceased.

Creditors, next-of-kin and others having claims in respect of the estate of the abovenamed deceased, who died on 28 June 2014, are required by the executor, Peter George Wollerman, care of Wollerman Shacklock Lawyers, of 8 Gloucester Avenue, Berwick, Victoria 3806, to send particulars of their claims to him by 18 June 2015, after which date the executor may convey or distribute the assets and distribute the estate, having regard only to the claims of which he then has notice. Probate was granted in Victoria on 16 March 2015.

WOLLERMAN SHACKLOCK LAWYERS,  
8 Gloucester Avenue, Berwick 3806.

---

#### ADVERTISEMENT OF AUCTION BY THE SHERIFF

On Thursday 28 May 2015 at 1.30 pm in the afternoon at the Sheriff's Office, 444 Swanston Street, Carlton (unless process be stayed or satisfied).

All the estate and interest (if any) of Andrew Karl Knorr of 42 Campbell Street, Traralgon, joint proprietor with Phillipa May Griffiths of an estate in fee simple in the land described on Certificate of Title Volume 08299 Folio 933, which is vacant land known as 4 Nelson Street, Port Albert, will be auctioned by the Sheriff.

Registered Mortgage (Dealing Number AE771077D) Registered Caveat (Dealing Number AG166727W) affect the said estate and interest. The Sheriff is unable to provide access to this property.

Terms: 10% deposit on the fall of the hammer. Balance within 14 days unless as stated in particulars of sale in contract of sale. Payment is by cheque only.

Please contact Sheriff's Asset Administration Services by email at [realestatesection@justice.vic.gov.au](mailto:realestatesection@justice.vic.gov.au) for an information sheet on Sheriff's auctions, a contract of sale and any other enquiries.

SHERIFF

---

#### ADVERTISEMENT OF AUCTION BY THE SHERIFF

On Thursday 28 May 2015 at 1.30 pm in the afternoon at the Sheriff's Office, 444 Swanston Street, Carlton (unless process be stayed or satisfied).

All the estate and interest (if any) of James William Vos of 18 Fisher Street, Stawell, joint proprietor with Stacey May Vos of an estate in fee simple in the land described on Certificate of Title Volume 10338 Folio 274, upon which is erected a dwelling and known as 18 Fisher Street, Stawell, will be auctioned by the Sheriff.

Registered Mortgage (Dealing Number AH029280X) Registered Caveat (Dealing Number AL220946R) affect the said estate and interest. The Sheriff is unable to provide access to this property.

Terms: 10% deposit on the fall of the hammer. Balance within 14 days unless as stated in particulars of sale in contract of sale. Payment is by cheque only.

Please contact Sheriff's Asset Administration Services by email at [realestatesection@justice.vic.gov.au](mailto:realestatesection@justice.vic.gov.au) for an information sheet on Sheriff's auctions, a contract of sale and any other enquiries.

SHERIFF

---



**GOVERNMENT AND OUTER BUDGET  
SECTOR AGENCIES NOTICES**

**BOROONDARA CITY COUNCIL**

**Road Discontinuance**

Pursuant to section 206 and Schedule 10, Clause 3 of the **Local Government Act 1989**, the Boroondara City Council has formed the opinion that the road at the rear of 9 and 11, 15 to 19 and 23 to 25 Compton Street, 79 and 81, 85 to 89 and 93 and 95 Highfield Road and 196 and 198 Prospect Hill Road, Canterbury, shown by hatching on the plan below, is not reasonably required as a road for public use and resolved to discontinue the road and to sell the land from the road by private treaty to the abutting property owners.

The road is to be sold subject to the right, power or interest held by the Boroondara City Council and Yarra Valley Water Corporation in the road in connection with any sewers, drains or pipes under the control of those authorities in or near the road.

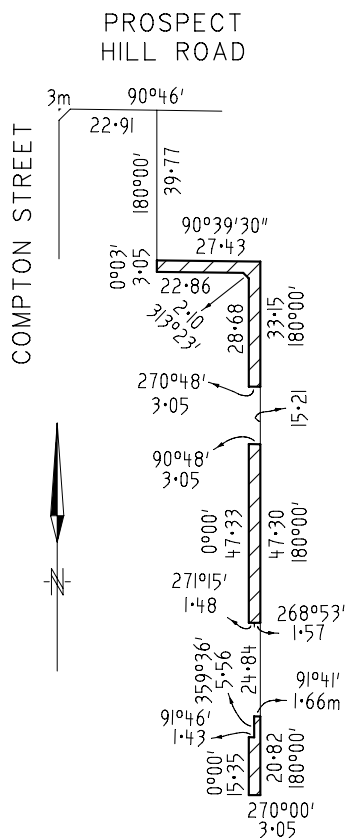

0 20 40 60  
LENGTHS ARE IN METRES

PARISH OF BOROONDARA  
PART OF CROWN PORTION 151

PHILLIP STORER  
Chief Executive Officer

BOROONDARA CITY COUNCIL

Road Discontinuance

Pursuant to section 206 and Schedule 10, Clause 3 of the **Local Government Act 1989**, the Boroondara City Council has formed the opinion that the road at the rear of 86 and 88 Albion Road and adjoining 2 Maxwell Street, Ashburton, shown hatched and cross-hatched on the plan below, is not reasonably required as a road for public use and resolved to discontinue the road and to sell the land from the road by private treaty to the abutting property owners.

The section of road shown cross-hatched is to be sold subject to the right, power or interest held by Yarra Valley Water Corporation in the road in connection with any sewers, drains or pipes under the control of that authority in or near the road.

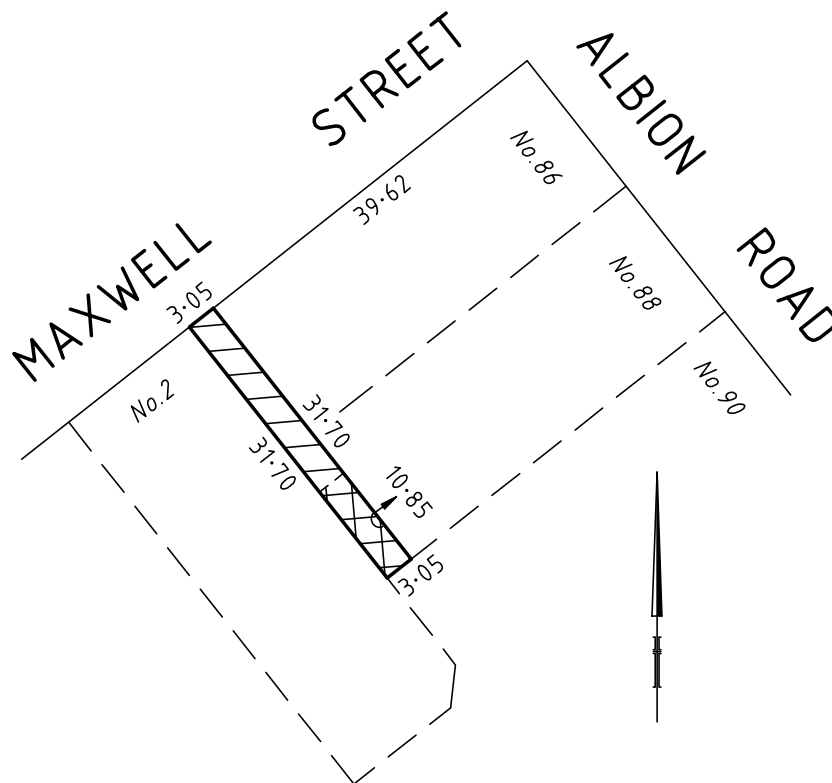

PHILLIP STORER  
Chief Executive Officer



**Local Government Act 1989**  
**ROAD DISCONTINUANCE**

Unused roads adjoining Byron Street, Footscray

Pursuant to section 206 and Schedule 10, Clause 3 of the **Local Government Act 1989**, Maribyrnong City Council resolved on 22 October 2013 to discontinue unused roads adjoining 40–54 Byron Street and 32E Leeds Street, Footscray, as shown in the hatched area on the plan below. These roads are not reasonably required for public use as a road now or in the future.

Published with the authority of the Chief Executive Officer of the Maribyrnong City Council, Council Offices, corner Napier and Hyde Street, Footscray 3011.

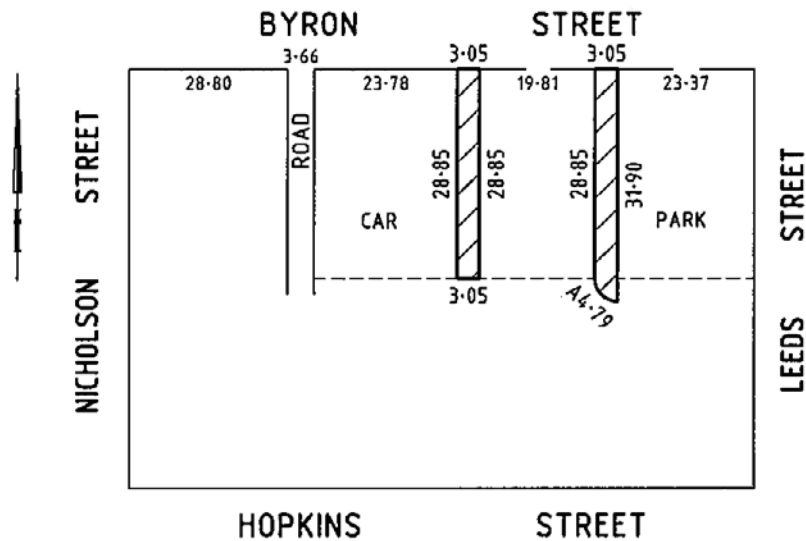

STEPHEN WALL  
 Chief Executive Officer  
 Maribyrnong City Council

PYRENEES SHIRE COUNCIL

Corrigendum

Road Deviation / Land Exchange / Road Declaration

This notice corrects an error contained in a notice published in the Victoria Government Gazette (G13) dated 2 April 2015 at page 712.

Pursuant to section 207E and Clause 2 of Schedule 10 of the **Local Government Act 1989** (the Act), the Pyrenees Shire Council, at its meeting on 17 February 2015, resolved to deviate the part of the existing road hatched on the plan of CA 33A Section 2 Parish of Glendhu hereunder, and exchange the part of the existing road hatched with part of the land contained in CA 33A Section 2 Parish of Glendhu and create the road cross-hatched on the plan.

Under clause 2(2) of Schedule 10 of the Act, consent was obtained on 14 August 2014 from the Minister for Environment and Climate Change, as the Responsible Minister administering the **Land Act 1958** (under delegated authority), to the proposed deviation and land exchange as shown on the plan below.

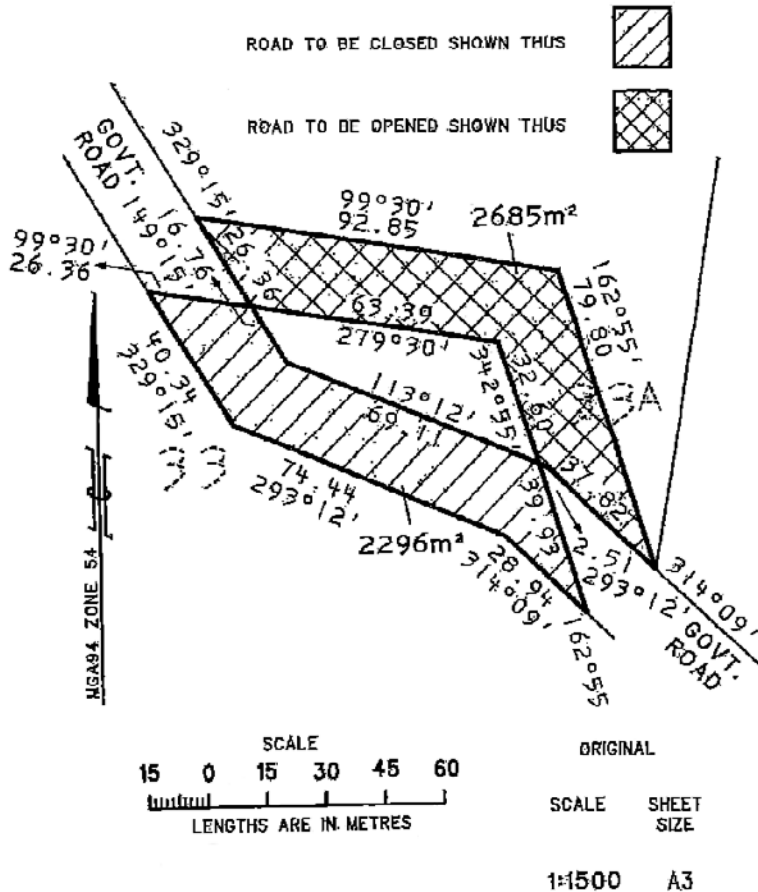

Pursuant to section 204(1) of the Act, Council declares the area cross-hatched as Public Highway.

JIM NOLAN  
Chief Executive Officer  
Pyrenees Shire Council

PYRENEES SHIRE COUNCIL

Corrigendum

Road Deviation / Land Exchange / Road Declaration

This notice corrects an error contained in a notice published in the Victoria Government Gazette (G13) dated 2 April 2015 at page 713.

Pursuant to section 207E and Clause 2 of Schedule 10 of the **Local Government Act 1989** (the Act), the Pyrenees Shire Council, at its meeting on 17 February 2015, resolved to deviate the part of the existing road hatched on the plan of CA 26A Section 2 Parish of Glendhu hereunder, and exchange the part of the existing road hatched with part of the land contained in CA 26A Section 2 Parish of Glendhu and create the road cross-hatched on the plan.

Under clause 2(2) of Schedule 10 of the Act, consent was obtained on 14 August 2014 from the Minister for Environment and Climate Change, as the Responsible Minister administering the **Land Act 1958** (under delegated authority), to the proposed deviation and land exchange as shown on the plan below.

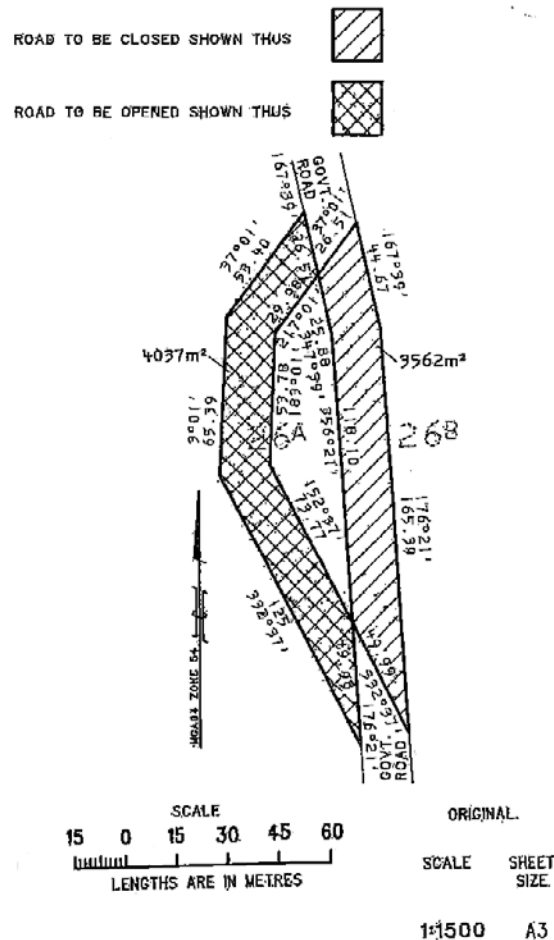

Pursuant to section 204(1) of the Act, Council declares the area cross-hatched as Public Highway.

JIM NOLAN  
Chief Executive Officer  
Pyrenees Shire Council



### MEETING PROCEDURE LOCAL LAW

Pursuant to section 119 of the **Local Government Act 1989** Baw Baw Shire Council, at its ordinary meeting held on Wednesday 11 March 2015, resolved to adopt the revised local law, Meeting Procedure Local Law. This local law is effective from March 11 2015.

The purpose of this Local Law is to:

- Facilitate good governance of the Baw Baw Shire Council;
- Regulate proceedings for the election of the Mayor;
- Regulate proceedings at all Ordinary and Special Meetings of Council and meetings of Special Committees;
- Regulate the use of confidential information;
- Regulate the use of the Common Seal and Prohibit its authorised use;
- Provide for the administration of the Council's powers and functions;
- Revoke Meeting Procedure Local Law 2012.

A copy of the Local Law may be viewed online at [www.bawbawshire.vic.gov.au](http://www.bawbawshire.vic.gov.au) and is available for viewing at one of our Customer Service Centres during business hours.

HELEN ANSTIS  
Chief Executive Officer



### GOVERNANCE LOCAL LAW NO. 1

Notice is hereby given pursuant to section 119(2) of the **Local Government Act 1989** that, at its meeting on 13 April 2015, Council resolved to make Governance Local Law No. 1, to provide for the orderly conduct of Council Meetings, election of the Mayor and use of the City Seal.

The Local Law deals with agendas, quorums, keeping of minutes, business of the meeting, voting at meetings, addressing a meeting, motions, speaking time, points of order, formal motions, amendments and rescission motions,

public participation, election of the Mayor and use of the City Seal. The Local Law also fixes penalties for breach of certain provisions.

A copy of the Local Law may be obtained from the Civic Centre, 30 Davey Street, Frankston, during office hours. The document can also be accessed on Council's website at [www.frankston.vic.gov.au](http://www.frankston.vic.gov.au)

DENNIS HOVENDEN  
Chief Executive Officer



Notice is given that the City of Greater Geelong, at its meeting on 22 October 2013, resolved to repeal the existing Orders made under the **Domestic (Feral and Nuisance) Animals Act 1994** and make the following Orders relating to the confinement of cats on domestic premises and the mandatory desexing of registered cats under sections 10A and 26 of the **Domestic Animals Act 1994**:

- a) The previous Orders made by Council under the **Domestic (Feral and Nuisance) Animals Act 1994** on 24 December 2008 are revoked.
  - b) All newly registered cats in the municipality must be desexed, unless otherwise exempt from any requirement to be desexed under the **Domestic Animals Act 1994**.
  - c) All registered cats in the municipality must be desexed by 30 June 2017 unless otherwise exempt from any requirement to be desexed under the **Domestic Animals Act 1994**.
  - d) A night curfew is imposed for cats. All cats must be securely confined to the owner's premises between sunset and sunrise each day.
- In this order:

'Desexed' in relation to a cat means having undergone a surgical procedure to remove all or part of the reproductive organs of the cat to prevent it breeding and to prevent or eliminate secondary sexual behaviours.

'Owner' in respect of a cat includes a person who keeps or harbours the animal or has the animal in his or her care for the time being whether the animal is at large or in confinement.

These Orders take effect the day they are published in the Government Gazette and in a newspaper circulating in the municipal district.

DR GILLIAN MILES  
Chief Executive Officer



### Local Government Act 1989

#### NOTICE OF AUTHORISATION OF VICTORIA POLICE OFFICERS

Pursuant to section 224A of the **Local Government Act 1989**, the Council authorises any police officer of the Victoria Police Force to enforce the provisions of the Hindmarsh Municipal Local Law 2014 clause 930 – Consumption of Alcohol. For the purposes of this authorisation, a police officer's certificate of identity is deemed to be an identity card issued under section 224(2) of the **Local Government Act 1989** and is deemed to comply with section 224(3).

TONY DOYLE  
Chief Executive Officer

### Planning and Environment Act 1987

#### GLEN EIRA PLANNING SCHEME

##### Notice of Preparation of Amendment

##### Amendment C130

The Glen Eira City Council has prepared Amendment C130 to the Glen Eira Planning Scheme.

The land affected by the Amendment is 101–113 (odd) Grange Road and 2–4 Watson Grove, Glen Huntly, and 118 Grange Road, Carnegie.

The Amendment proposes to change the Glen Eira Planning Scheme by applying the Environmental Audit Overlay to the subject sites.

You may inspect the Amendment, any documents that support the Amendment and the explanatory report about the Amendment, free of charge, at the following locations: during office hours, at the office of the planning authority, Glen Eira City Council, corner Glen Eira and Hawthorn Roads, Caulfield South; or at the Department of Environment, Land, Water and Planning website, [www.dtpli.vic.gov.au/publicinspection](http://www.dtpli.vic.gov.au/publicinspection)

Any person who may be affected by the Amendment may make a submission to the planning authority. Submissions must be made in

writing giving the submitter's name and contact address, clearly stating the grounds on which the Amendment is supported or opposed and indicating what changes (if any) the submitter wishes to make.

Name and contact details of submitters are required for Council to consider submissions and to notify such persons of the opportunity to attend Council meetings and any public hearing held to consider submissions. In accordance with the **Planning and Environment Act 1987**, Council must make available for inspection a copy of any submissions made.

The closing date for submissions is Monday 18 May 2015. A submission must be sent to the Strategic Planning, Glen Eira City Council, PO Box 42, Caulfield South, Victoria 3162.

The following panel hearing dates have been set for this Amendment:

- directions hearing: week commencing 27 July 2015.
- panel hearing: week commencing 17 August 2015.

RON TORRES  
Director Planning And Transport

### Planning and Environment Act 1987

#### GREATER SHEPPARTON PLANNING SCHEME

##### Notice of Preparation of Amendment

##### Amendment C180

Greater Shepparton City Council has prepared Amendment C180 to the Greater Shepparton Planning Scheme.

The land affected by the Amendment is 289 Maude Street, Shepparton, and the land known as 'ROAD' on TP393266 (which provides access to 289 Maude Street, Shepparton, from Vaughan Street, Shepparton).

The purpose of the Amendment is to facilitate the implementation of the proposed Maude Street Bus Interchange Master Plan.

The Amendment proposes to apply the Public Acquisition Overlay (PAO20) to 289 Maude Street, Shepparton, and apply the Road Closure Overlay to the land shown as 'ROAD' on TP393266. It is intended that part of the land to be acquired and the land from the 'ROAD' will be exchanged for adjoining land to facilitate the development of land for the proposed bus interchange.

You may inspect the Amendment, any documents that support the Amendment and the explanatory report about the Amendment, free of charge, at the following locations: during office hours, at the office of the planning authority, Greater Shepparton City Council, 90 Welsford Street, Shepparton; at the Greater Shepparton City Council website, [www.greatershepparton.com.au](http://www.greatershepparton.com.au); and at the Department of Environment, Land, Water and Planning website, [www.dtpli.vic.gov.au/publicinspection](http://www.dtpli.vic.gov.au/publicinspection).

Any person who may be affected by the Amendment may make a submission to the planning authority. Submissions must be made in writing giving the submitter's name and contact address, clearly stating the grounds on which the Amendment is supported or opposed and indicating what changes (if any) the submitter wishes to make.

Name and contact details of submitters are required for Council to consider submissions and to notify such persons of the opportunity to attend Council meetings and any public hearing held to consider submissions. In accordance with the **Planning and Environment Act 1987**, Council must make available for inspection a copy of any submissions made.

The closing date for submissions is 18 May 2015. A submission must be sent to the Greater Shepparton City Council, Locked Bag 1000, Shepparton, Victoria 3632.

The following panel hearing dates have been set for this Amendment:

- directions hearing: to commence in the week of 29 June 2015.
- panel hearing: to commence in the week of 27 July 2015.

Colin Kalms  
MANAGER PLANNING

### **Planning and Environment Act 1987**

#### WHITTLESEA PLANNING SCHEME

Notice of the Preparation of an Amendment to a Planning Scheme and

Notice of an Application for Planning Permit Given Under Section 9(1) of the

### **Planning and Environment Act 1987**

#### Amendment C188

The land affected by the Amendment, known as the Quarry Hills precinct, is generally bound by Lehmans Road to the north, the Quarry Hills Regional Parkland to the east, an existing transmission easement to the south and the E6 Public Acquisition Overlay to the west.

The Amendment proposes to make a number of changes to the planning scheme to facilitate the development and use of land within the Quarry Hills PSP area.

Specifically the Amendment:

- incorporates two new incorporated documents titled Quarry Hills Precinct Structure Plan, April 2015 (PSP) and Quarry Hills Development Contributions Plan, April 2015 (DCP) into the Whittlesea Planning Scheme and implements the PSP and DCP, and makes the following changes to the Whittlesea Planning Scheme;
- inserts Schedule 3 to Clause 37.07 Urban Growth Zone (UGZ) into the Whittlesea Planning Scheme and applies the UGZ Schedule 3 (UGZ3) to part of the land within the Amendment area;
- rezones land from Farming Zone (FZ) to UGZ Schedule 3 (UGZ3) to part of the land within the Amendment area;
- rezones land from Farming Zone (FZ) to Rural Conservation Zone (RCZ) along the Darebin Creek and Growling Grass Frog Conservation Area;
- rezones land from Rural Conservation Zone (RCZ) to UGZ Schedule 3 (UGZ3) to part of the land within the Amendment area;
- rezones land from Special Use Zone Schedule 4 to UGZ Schedule 3 (UGZ3) to part of the land within the Amendment area;
- inserts Schedule 8 to Clause 37.01 Special Use Zone (SUZ) into the Whittlesea Planning Scheme and applies the SUZ Schedule 8 to the transmission easement within the Amendment area;
- rezones land from Farming Zone to Special Use Zone Schedule 8 (SUZ8) to land within the transmission easement within the Amendment area;
- inserts Schedule 3 to Clause 43.03 Incorporated Plan Overlay (IPO) into the Whittlesea Planning Scheme and applies the IPO Schedule 3 to land zoned Rural Conservation Zone within the Amendment area;
- inserts Schedule 13 to Clause 45.06 Development Contributions Plan Overlay (DCPO) into the Whittlesea Planning Scheme and applies the DCPO Schedule 13 to land within the Amendment area;



- deletes Environmental Significance Overlays Schedule 1 (ESO1) and Schedule 5 (ESO5) from land within the Amendment area;
- amends the Schedule to Clause 52.01 to provide for passive open space contributions for land within the Amendment area;
- amends the Schedule to Clause 52.17 to identify native vegetation that can be removed without the need for a planning permit;
- amends the Schedule to Clause 61.03 to update the planning scheme maps in the Whittlesea Planning Scheme; and
- amends the Schedule to Clause 81.01 to include the new incorporated documents titled 'Quarry Hills Precinct Structure Plan, April 2015' and 'Quarry Hills Development Contributions Plan, April 2015'.

You may inspect the Amendment, any documents that support the Amendment and the explanatory report about the Amendment: during office hours, at the following places: Metropolitan Planning Authority, Level 25, 35 Collins Street, Melbourne 3000; Whittlesea City Council, 25 Ferres Boulevard, South Morang, Victoria 3752; on the Metropolitan Planning Authority website, [www.mpa.vic.gov.au](http://www.mpa.vic.gov.au); or on the Department of Environment, Land, Water and Planning website, [www.dtpli.vic.gov.au/publicinspection](http://www.dtpli.vic.gov.au/publicinspection)

Any person who may be affected by the Amendment may make a submission to the planning authority. Submissions must be made in writing giving the submitter's name and contact address, clearly stating the grounds on which the Amendment is supported or opposed and indicating what changes (if any) the submitter wishes to make.

Name and contact details of submitters are required for the Metropolitan Planning Authority to consider submissions and to notify such persons of the opportunity to attend any meetings held to consider submissions. In accordance with the **Planning and Environment Act 1987**, the Metropolitan Planning Authority must make available for inspection a copy of any submissions made.

The closing date for submissions is 18 May 2015. A submission must be sent to: Metropolitan Planning Authority, Whittlesea Planning Scheme Amendment C188, Level 25,

35 Collins Street, Melbourne 3000; or via email to [amendments@mpa.vic.gov.au](mailto:amendments@mpa.vic.gov.au) and reference 'Submission to Amendment C188'.

The following panel hearing dates have been set for this Amendment:

- directions hearing: week beginning 15 June 2015.
- panel hearing: week beginning 20 July 2015\*.

\*Please note dates are subject to change.



### **Planning and Environment Act 1987**

#### **YARRA PLANNING SCHEME**

#### Notice of Preparation of Amendment

#### Amendment C181

The Yarra City Council has prepared Amendment C181 to the Yarra Planning Scheme.

The land affected by the Amendment is 10 Bedford Street, Collingwood.

The Amendment proposes to rezone the land from a Public Use Zone Schedule 2 (Education) to a General Residential Zone.

You may inspect the Amendment, any documents that support the Amendment and the explanatory report about the Amendment, free of charge, at the following locations: during office hours, at the office of the planning authority, City of Yarra, Richmond Town Hall, 333 Bridge Road, Richmond; or at the Department of Environment, Land, Water and Planning website, [www.dtpli.vic.gov.au/publicinspection](http://www.dtpli.vic.gov.au/publicinspection)

Any person who may be affected by the Amendment may make a submission to the planning authority. Submissions must be made in writing giving the submitter's name and contact address, clearly stating the grounds on which the Amendment is supported or opposed and indicating what changes (if any) the submitter wishes to make.

Name and contact details of submitters are required for Council to consider submissions and to notify such persons of the opportunity to attend Council meetings and any public hearing held to consider submissions. In accordance with the **Planning and Environment Act 1987**, Council must make available for inspection a copy of any submissions made.

The closing date for submissions is Monday 18 May 2015.

A submission must be sent to the City of Yarra, Strategic Planning, PO Box 168, Richmond 3121, or via email to [strategicplanning@yarracity.vic.gov.au](mailto:strategicplanning@yarracity.vic.gov.au)

The following panel hearing dates have been set for this Amendment:

- directions hearing: week commencing 20 July 2015.
- panel hearing: week commencing 17 August 2015.

For more information contact Elizabeth Brant, Strategic Planner on 9205 5332 or at [Elizabeth.Brant@yarracity.vic.gov.au](mailto:Elizabeth.Brant@yarracity.vic.gov.au)

DAVID WALMSLEY  
Manager City Strategy

Creditors, next-of-kin and others having claims against the estate of any of the undermentioned deceased persons are required to send particulars of their claims to State Trustees Limited, ABN 68 064 593 148, of 1 McNab Avenue, Footscray, Victoria 3011, the personal representative, on or before 17 June 2015, after which date State Trustees Limited may convey or distribute the assets, having regard only to the claims of which State Trustees Limited then has notice.

ANGELL, Leonard Thomas Henry, late of Banfield Aged Care, 192 Thompson Avenue, Cowes, Victoria 3922, retired, deceased, who died on 31 January 2015.

HUTCHINSON, Kenneth Geddes, late of 671 Staffordshire Reef Road, Staffordshire Reef, Victoria 3351, deceased, who died on 5 October 2014.

KLINGNER, Hubert, late of 2 Newton Street, Ferntree Gully, Victoria 3156, deceased, who died on 11 August 2014.

MACGREGOR, Ian, late of Amity At Edithvale, 256 Station Street, Edithvale, Victoria 3196, deceased, who died on 19 September 2014.

MATHES, Claire Sadie, also known as Clarice Sadie Mathes and Claire Sady Mathes, late of Crowley Retirement Village, 154 Cherry Street, Ballina, NSW 2478, pensioner, deceased, who died on 31 December 2014.

MEDLEY, Clarence Henry, late of Shelton Manor, 93 Ashleigh Avenue, Frankston, Victoria 3199, deceased, who died on 4 October 2014.

MILLER, Peter, late of Jack Lonsdale Lodge, 232 Spencer Street, Sebastopol, Victoria 3356, pensioner, deceased, who died on 23 November 2014.

OSMAN, Reshat, late of Homewood Residential Aged Care, 8 Young Road, Hallam, Victoria 3803, deceased, who died on 26 September 2014.

WILLIAMSON, Dawna Beryl, late of Bowhaven Hostel, 2 Swinbourne Avenue, Rainbow, Victoria 3424, deceased, who died on 20 November 2014.

Dated 8 April 2015

STEWART MacLEOD  
Manager

Creditors, next-of-kin and others having claims against the estate of any of the undermentioned deceased persons are required to send particulars of their claims to State Trustees Limited, ABN 68 064 593 148, of 1 McNab Avenue, Footscray, Victoria 3011, the personal representative, on or before 19 June 2015, after which date State Trustees Limited may convey or distribute the assets, having regard only to the claims of which State Trustees Limited then has notice.

BRIGGS, Vivienne Anne, late of Ron Conn Nursing Home, 33 Westminster Drive, Avondale Heights, Victoria, deceased, who died on 29 November 2014.

HIGGINS, John Reginald, late of Sambell Lodge, 1 South Terrace, Clifton Hill, Victoria, butcher, deceased, who died on 10 October 2014, Grant of Probate dated 31 March 2015.

STEWART, Dorothy May, late of Napier Street Aged Care, 179 Napier Street, South Melbourne, Victoria, retired, deceased, who died on 3 January 2015.

THYNNE, John Douglas, late of 15 Golfview Road, Heatherton, Victoria, deceased, who died on 4 October 2013.

Dated 10 April 2015

STEWART MacLEOD  
Manager

Department of Treasury and Finance

**SALE OF CROWN LAND  
BY PUBLIC AUCTION**

on Saturday 9 May 2015 at 12.30 pm on site

**Reference:** F14/4807.

**Address of Property:** Rennie Street, Lara.

**Crown Description:** Crown Allotment A3,  
Section 6, Township of Lara, Parish of  
Woomyalook.

**Terms of Sale:** Deposit 10%, balance in 60 days  
or earlier by mutual agreement.

**Area:** 507m<sup>2</sup>.

**Officer Co-ordinating Sale:** Andrew Martin,  
Senior Project Manager, Land and Property,  
Department of Treasury and Finance, Level 5,  
1 Treasury Place, Melbourne, Victoria 3002.

**Selling Agent:** Burns Archer Realty, 1/1–11  
Station Lake Road, Lara, Victoria 3212.

ROBIN SCOTT MP  
Minister for Finance

Department of Treasury and Finance

**SALE OF CROWN LAND  
BY PUBLIC AUCTION**

on 15 May 2015 at 12.00 pm on site

**Reference:** F13/6009.

**Address of Property:** Wishart Street, Wonthaggi.

**Crown Description:** Crown Allotment 2018,  
Township of Wonthaggi, Parish of Wonthaggi.

**Terms of Sale:** Deposit 10%, balance 90 days.

**Area:** 1,082m<sup>2</sup>.

**Officer Co-ordinating Sale:** Brian Dee, Senior  
Project Manager, Land and Property Group,  
Department of Treasury and Finance, Level 5,  
1 Treasury Place, Melbourne, Victoria 3002.

**Selling Agent:** PBE Real Estate, 38–40 McBride  
Avenue, Wonthaggi, Victoria 3995.

ROBIN SCOTT MP  
Minister for Finance

**Country Fire Authority Act 1958**

**VARIATION OF FIRE DANGER PERIOD**

In pursuance of the powers conferred by  
section 4 of the **Country Fire Authority Act  
1958**, I, Euan Ferguson, Chief Officer of the  
Country Fire Authority, after consultation  
with the Secretary to the Department of

Environment, Land, Water and Planning, hereby  
vary the declaration of the Fire Danger Periods  
previously published in the Government Gazette  
by declaring that such Fire Danger Periods  
shall end in respect of the undermentioned  
Municipal Districts of Municipalities or parts of  
Municipalities specified.

To terminate from 0100 hours on 20 April  
2015:

- Glenelg Shire Council
- West Wimmera Shire Council (Remainder).

EUAN FERGUSON AFSM  
Chief Officer

**Education and Training Reform Act 2006**

**NOTICE OF ORDER**

Notice is given that on 19 March 2015  
an order (Ministerial Order No. 813) was  
made under subsection (1) of section 2.3.2  
of the **Education and Training Reform Act  
2006** constituting a school council for Officer  
Secondary College.

THE HON. JAMES MERLINO, MP  
Deputy Premier  
Minister for Education

**Land Acquisition and Compensation Act 1986**

**FORM 7**

S. 21(a)  
Reg. 16

**Notice of Acquisition**

**Compulsory Acquisition of Interest in Land**

The Roads Corporation (VicRoads) declares  
that by this notice it acquires the following  
interest in the land described as part of Plan of  
Consolidation 150342, Parish of Maribyrnong,  
comprising 302.0 square metres and being land  
described in Certificate of Title Volume 09385  
Folio 922, shown as Parcel 2 on Survey Plan  
23190B.

**Interest Acquired:** That of ALH Group  
Property Holdings Pty Ltd and all other interests.

Published with the authority of VicRoads.

For and on behalf of VicRoads:

Signed ROD ROETMAN

Name Rod Roetman

Dated 13 April 2015

**Crown Land (Reserves) Act 1978****ORDER GIVING APPROVAL TO GRANT A LEASE UNDER  
SECTIONS 17D AND 17DA**

Under sections 17D and 17DA of the **Crown Land (Reserves) Act 1978**, I, the Hon. Lisa Neville MP, Minister for Environment, Climate Change and Water, being satisfied that there are special reasons which make the granting of a lease reasonable and appropriate in the particular circumstances and to do this will not be substantially detrimental to the use and enjoyment of any adjacent land reserved under the **Crown Land (Reserves) Act 1978**, approve the granting of a lease by Southern Grampians Shire Council, as Committee of Management, to NBN Co Ltd for the purpose of the construction, maintenance and operations of a telecommunications network and telecommunications service over part of the Mt Rouse Public Park Reserve as described in the Schedule below and, in accordance with section 17D(3)(a) of the **Crown Land (Reserves) Act 1978**, state that –

- (a) there are special reasons which make granting a lease reasonable and appropriate in the particular circumstances; and
- (b) to do this will not be substantially detrimental to the use and enjoyment of any adjacent land reserved under the **Crown Land (Reserves) Act 1978**.

**SCHEDULE**

The area of land shown hatched on the attached plan, being part of the land permanently reserved in the Parish of Purdeet for a Public Park by Order in Council of 19 August 1872, (vide Government Gazette of 1872 on page 1582).

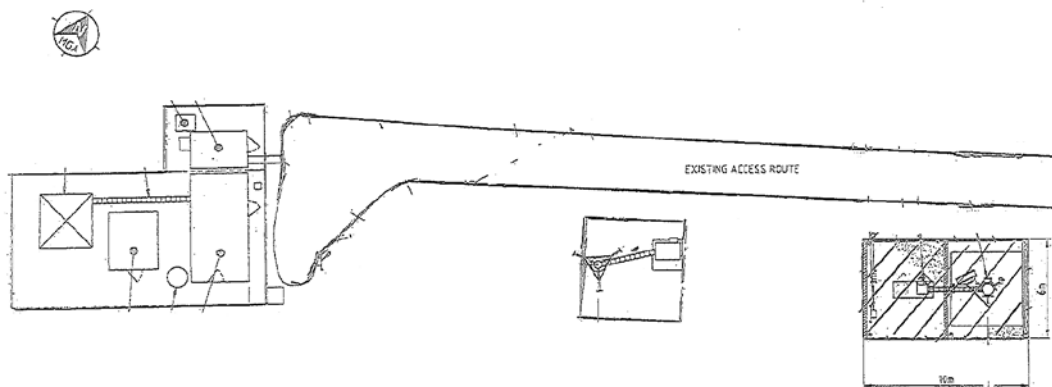

File Reference: 03L2/4879

Dated 23 March 2015

THE HON. LISA NEVILLE MP  
Minister for Environment, Climate Change and Water

**Conservation, Forests and Lands Act 1987****NOTICE OF MAKING OF A LAND MANAGEMENT CO-OPERATIVE AGREEMENT**

Notice is given under section 80 of the **Conservation, Forests and Lands Act 1987** that a Land Management Co-operative Agreement has been entered into by the Secretary to the Department of Environment, Land, Water and Planning with the following landowners.

A copy of the Agreement is available for public inspection between the hours of 9.00 am and 5.00 pm at Regulatory Strategy & Design Branch, Department of Environment, Land, Water and Planning, Level 2, 8 Nicholson Street, East Melbourne 3002 and at the relevant regional Department of Environment, Land, Water and Planning office.

<b>Registered Proprietor</b>	<b>Site Location</b>	<b>Title Details- Volume/Folio</b>	<b>Dealing No. of Agreement</b>
Melbourne Office	8 Nicholson Street, East Melbourne 3002		
355 Donnybrook Road Pty Ltd	Lot F on Plan of Subdivision 705986T, Parish of Mickleham	11546/648	AL696872L
495 Donnybrook Road Pty Ltd	Lot 2 on Plan of Subdivision 212494E, Parish of Mickleham	9829/357	AL280470C

Dated 16 April 2015

ADAM FENNESSY  
Secretary

Department of Environment, Land, Water and Planning

**Housing Act 1983****LAND THE DIRECTOR OF HOUSING IS DEEMED TO HAVE AN INTEREST IN UNDER SECTION 107 OF THE HOUSING ACT 1983**

Uniting Care Housing Victoria Ltd

I, Arthur Rogers, Director of Housing (the Director), hereby issue the following declaration pursuant to section 107 of the **Housing Act 1983** (the Act).

The Director and Uniting Care Housing Victoria Ltd have agreed in writing that the following land of which Uniting Care Housing Victoria Ltd is registered as proprietor is land to which section 107 of the Act should apply and is therefore land in which the Director is deemed to have an interest under section 107.

<b>Volume</b>	<b>Folio</b>	<b>Address</b>
09244	950	9 Weabra Court, Delacombe

Dated 30 March 2015

Signed at Melbourne in the State of Victoria  
ARTHUR ROGERS  
Director of Housing

**Geographic Place Names Act 1998****NOTICE OF REGISTRATION OF GEOGRAPHIC NAMES**

The Registrar of Geographic Names hereby gives notice of the registration of the undermentioned place names.

**Road Naming:**

<b>Change Request Number</b>	<b>Road Name</b>	<b>Locality</b>	<b>Naming Authority and Location</b>
74819	Kookaburra Lane	Lance Creek and Kongwak	Bass Coast Shire Council The road traverses south from Korumburra–Wonthaggi Road.
81110	McIntyre Lane	Parkville	Melbourne City Council The road traverses north from Tullamarine Freeway.
81110	Yates Lane	Parkville	Melbourne City Council The road traverses south from Manningham Street.
81110	Heathcote Road	Parkville	Melbourne City Council The road traverses south from Manningham Street.
81133	Danks Lane	Kensington	Melbourne City Council The road traverses east from Epsom Road.
84282	Niemann Lane	Edithvale	Kingston City Council The road traverses west from Baker Avenue.
84380	High Street	Hamilton	Southern Grampians Shire Council Formerly known as part Gordon Street. The road traverses north from Dickens Street and is a continuation of the existing High Street.
84379	College Street	Hamilton	Southern Grampians Shire Council Formerly known as part Park Street. The road traverses north from Horner Street and is a continuation of the existing College Street.

**Feature Naming:**

<b>Place Name</b>	<b>Naming Authority and Location</b>
Avenel (Recreation Reserve Pavilion) Neighbourhood Safer Place	Country Fire Authority Located at Avenel Recreation Reserve Pavilion.
Kilmore (Racecourse Trackside Function Centre) Neighbourhood Safer Place	Country Fire Authority Located at Kilmore Racecourse Trackside Function Centre.

Office of Geographic Names

Land Victoria  
570 Bourke Street  
Melbourne 3000

JOHN E. TULLOCH  
Registrar of Geographic Names

**Interpretation of Legislation Act 1984****HERITAGE (GENERAL) REGULATIONS 2015****Notice of Incorporation of Material and Address for Inspection of Documents**

Notice is given under section 32(3)(a)(ii) of the **Interpretation of Legislation Act 1984** that the Heritage (General) Regulations 2015 apply, adopt or incorporate the documents set out in the table below.

**Table of Applied, Adopted or Incorporated Matter Required by the Subordinate Legislation Regulations 2004**

<b>Statutory rule provision</b>	<b>Title of applied, adopted or incorporated document</b>	<b>Matter in applied, adopted or incorporated document</b>
Regulation 18	Guidelines for Conducting Historical Archaeological Surveys (published by Heritage Council of Victoria in July 2008).	Section 3.2

A copy of the material applied, adopted or incorporated by the Regulations has been lodged with the Clerk of the Parliaments.

A copy of all matters so applied, adopted or incorporated into the Heritage (General) Regulations 2015 is available for inspection by the public, free of charge, during normal business hours, at the Department of Environment, Land, Water and Planning at 1 Spring Street, Melbourne, telephone 9208 3726.

Dated 13 April 2015

RICHARD WYNNE MP  
Minister for Planning

**Subordinate Legislation Act 1994****NOTICE OF INTENTION TO MAKE A LEGISLATIVE INSTRUMENT**

(Section 12J)

**Scale of Fees and Charges for Services for a Class A Cemetery Trust**

I, Bryan Crampton, as delegate of the Secretary to the Department of Health and Human Services, under section 40 of the **Cemeteries and Crematoria Act 2003**, give notice of my decision to approve the proposed Scale of Fees and Charges for Services for the Southern Metropolitan Cemeteries Trust, being a Class A cemetery trust.

A regulatory impact statement was prepared and a public call for submissions was undertaken in relation to the proposed Scale of Fees and Charges for Services for the Southern Metropolitan Cemeteries Trust. The Victorian Competition and Efficiency Commission issued a notice of adequacy for the regulatory impact statement and no submissions were received for consideration.

The objective of the proposed Scale of Fees and Charges for Services for the Southern Metropolitan Cemeteries Trust is to introduce a new set of pricing arrangements for the purchase of cemetery services relating to the sale of rights of interment for mausoleum crypts, for new graves and for cremation memorialisation products.

I have decided that the proposed legislative instrument is to be made and will come into effect upon gazettal of the instrument in the Victoria Government Gazette.

BRYAN CRAMPTON  
Delegate of the Secretary

**Road Safety Act 1986**DECLARATION UNDER SECTION 99B(4) IN RELATION TO  
THE BRIGHT AUTUMN FESTIVAL GALA DAY PARADE,  
BRIGHT, ON 2 MAY 2015**1 Purpose**

The purpose of this Declaration is to exempt participants in the Bright Autumn Festival Gala Day Parade from specified provisions of the Road Safety Road Rules 2009 with respect to the Event, which is a non-road activity to be conducted on Great Alpine Road (Gavan Street and Delaney Avenue), Park Street, Ireland Street, Bakers Gully Road, Anderson Street and Mountbatten Avenue, Bright, on 2 May 2015.

**2 Authorising provision**

This notice is made under section 99B(4) of the **Road Safety Act 1986**. Section 99B(4) provides that the Minister may, on the application of a person proposing to conduct a non-road activity on a highway, by notice published in the Government Gazette, declare that specified provisions of the **Road Safety Act 1986** and of the regulations made under that Act do not apply with respect to the non-road activity specified in the notice during the period specified in the notice.

**3 Commencement**

This notice takes effect on 2 May 2015 at 1.15 pm.

**4 Expiry**

This notice expires on 2 May 2015 at 3.30 pm.

**5 Definitions**

In this notice, unless the context or subject matter otherwise requires –

- (a) ‘Event’ means the Bright Autumn Festival Gala Day Parade, to be held on 2 May 2015; and
- (b) ‘Participants’ means participants in the Event, including officers, members and authorised agents of the Bright Autumn Festival Committee, whose presence is reasonably required to ensure the safe conduct of the Event.

**6 Declaration**

I, Michael McCarthy, Acting Executive Director Regional Operations, as delegate of the Minister for Roads, under section 99B(4) of the **Road Safety Act 1986** declare that the provisions of the Road Safety Road Rules 2009 specified in Table 1 do not apply to Participants engaged in activities forming part of the Event on the highway specified in column 1 of Table 2, on the date and during the period specified in column 2 of Table 2.

**Table 1****Provisions of the Road Safety Road Rules 2009 that do not apply to participants in the Event**

<b>Road Safety Road Rules 2009</b>	
Part 9	Roundabouts
Part 11	Keeping Left, Overtaking and Other Driving Rules
Part 12	Restrictions on Stopping and Parking
Part 14	Rules for Pedestrians
Part 16	Rules for Persons Travelling on or in Vehicles
Rule 298	Driving with a person in a trailer



**Table 2**

<i>Column 1</i> <b>Highway</b>	<i>Column 2</i> <b>Date and time</b>
Great Alpine Road (Gavan Street and Delaney Avenue), Park Street, Ireland Street, Bakers Gully Road, Anderson Street and Mountbatten Avenue, Bright	2 May 2015, between 1.15 pm and 3.30 pm

Dated 10 April 2015

MICHAEL McCARTHY  
Acting Executive Director Regional Operations  
Roads Corporation

**Planning and Environment Act 1987**

## DAREBIN PLANNING SCHEME

## Notice of Approval of Amendment

## Amendment C130

The Minister for Planning has approved Amendment C130 to the Darebin Planning Scheme.

The Amendment comes into operation on the date this notice is published in the Government Gazette.

The Amendment:

- rezones the land from General Residential 2 Zone to Priority Development Zone 2 (Preston Central);
- amends Schedule 2 to the Priority Development Zone;
- amends the Preston Central Incorporated Plan March 2007; and
- makes consequential changes to Clause 21.05-6, Clause 22.12 and the schedule to Clause 81.01.

A copy of the Amendment can be inspected, free of charge, at the Department of Environment, Land, Water and Planning website at [www.delwp.vic.gov.au/public-inspection](http://www.delwp.vic.gov.au/public-inspection) and free of charge, during office hours, at the offices of the Darebin City Council, 274 Gower Street, Preston, Victoria 3072.

JIM GARDNER  
Executive Director  
Statutory Planning and Heritage  
Department of Environment, Land, Water and Planning

**Planning and Environment Act 1987**

## DAREBIN PLANNING SCHEME

## Notice of Approval of Amendment

## Amendment C135

The Minister for Planning has approved Amendment C135 to the Darebin Planning Scheme.

The Amendment comes into operation on the date this notice is published in the Government Gazette.

The Amendment:

- amends Schedule 2 of the Priority Development Zone and the Preston Central Incorporated Plan – March 2007 to remove the prohibition of dwellings in Precinct H of the Preston Central area; and
- amends Clause 21.05, Clause 22.08 and the schedule to Clause 81.01 to reflect the new provisions for Precinct H.

A copy of the Amendment can be inspected, free of charge, at the Department of Environment, Land, Water and Planning website at [www.delwp.vic.gov.au/public-inspection](http://www.delwp.vic.gov.au/public-inspection) and free of charge, during office hours, at the offices of the Darebin City Council, 274 Gower Street, Preston 3072.

JIM GARDNER  
Executive Director  
Statutory Planning and Heritage  
Department of Environment, Land, Water and Planning

**Planning and Environment Act 1987**  
**FRANKSTON PLANNING SCHEME**  
 Notice of Approval of Amendment  
 Amendment C102

The Minister for Planning has approved Amendment C102 to the Frankston Planning Scheme.

The Amendment comes into operation on the date this notice is published in the Government Gazette.

The Amendment rezones 23R and 25R Margate Avenue, Frankston (known as Lots 186 and 187 on LP8764) from a Public Use Zone Schedule 6 (Local government) to a General Residential Zone – Schedule 1.

A copy of the Amendment can be inspected, free of charge, at the Department of Environment, Land, Water and Planning website at [www.delwp.vic.gov.au/public-inspection](http://www.delwp.vic.gov.au/public-inspection) and free of charge, during office hours, at the offices of the Frankston City Council, 30 Davey Street, Frankston.

JIM GARD'NER  
 Executive Director  
 Statutory Planning and Heritage  
 Department of Environment, Land, Water and Planning

**Planning and Environment Act 1987**  
**GREATER DANDENONG PLANNING SCHEME**  
 Notice of Approval of Amendment  
 Amendment C170

The Minister for Planning has approved Amendment C170 to the Greater Dandenong Planning Scheme.

The Amendment comes into operation on the date this notice is published in the Government Gazette.

The Amendment rezones land at 417–425 Princes Highway, Noble Park, from a General Residential Zone – Schedule 1 to a Mixed Use Zone to be developed and used for warehouses, with ancillary showrooms and offices.

The Minister has granted the following permit under Division Five Part Four of the Act:

<b>Permit No.</b>	<b>Description of land</b>
PLN12/0468	409–423 Princes Highway, Noble Park

A copy of the Amendment can be inspected, free of charge, at the Department of Environment, Land, Water and Planning website at [www.delwp.vic.gov.au/public-inspection](http://www.delwp.vic.gov.au/public-inspection) and free of charge, during office hours, at the offices of the Greater Dandenong City Council, 39 Clow Street, Dandenong.

JIM GARD'NER  
 Executive Director  
 Statutory Planning and Heritage  
 Department of Environment, Land, Water and Planning

**Planning and Environment Act 1987**

**KNOX PLANNING SCHEME**

**Notice of Approval of Amendment**

**Amendment C135**

The Minister for Planning has approved Amendment C135 to the Knox Planning Scheme.

The Amendment comes into operation on the date this notice is published in the Government Gazette.

The Amendment rezones land at 7 Church Street, Bayswater, from Public Use Zone 6 to the Residential Growth Zone Schedule 2.

A copy of the Amendment can be inspected, free of charge, at the Department of Environment, Land, Water and Planning website at [www.delwp.vic.gov.au/public-inspection](http://www.delwp.vic.gov.au/public-inspection) and free of charge, during office hours, at the offices of the Knox City Council, 511 Burwood Highway, Wantirna South.

JIM GARDNER  
Executive Director  
Statutory Planning and Heritage  
Department of Environment, Land, Water and Planning

---

**Planning and Environment Act 1987**

**MAROONDAH PLANNING SCHEME**

**Notice of Approval of Amendment**

**Amendment C99**

The Minister for Planning has approved Amendment C99 to the Maroondah Planning Scheme.

The Amendment comes into operation on the date this notice is published in the Government Gazette.

The Amendment rezones the northern portion of land known as 48, 50 and 52 Nelson Street, Ringwood, from an Urban Floodway Zone (UFZ) to a Residential Growth Zone Schedule 1 (RGZ1).

A copy of the Amendment can be inspected, free of charge, at the Department of Environment, Land, Water and Planning website at [www.delwp.vic.gov.au/public-inspection](http://www.delwp.vic.gov.au/public-inspection) and free of charge, during office hours, at the offices of the Maroondah City Council, Braeside Avenue, Ringwood.

JIM GARDNER  
Executive Director  
Statutory Planning and Heritage  
Department of Environment, Land, Water and Planning

---

**Planning and Environment Act 1987**  
MORNINGTON PENINSULA PLANNING SCHEME  
Notice of Approval of Amendment  
Amendment C176 (Part 2)

The Minister for Planning has approved Amendment C176 (Part 2) to the Mornington Peninsula Planning Scheme.

The Amendment comes into operation on the date this notice is published in the Government Gazette.

The Amendment:

- rezones 70 Mountain View Road, Mt Eliza, from a General Residential Zone Schedule 1 to a Commercial 1 Zone and includes the land as a 'convenience centre' in Table 1 to Clause 21.07-3;
- rezones part 520 Arthurs Seat Road, Red Hill, from a Public Conservation and Resource Zone to a Green Wedge Zone Schedule 2 and 520A Arthurs Seat Road, Red Hill, from a Green Wedge Zone Schedule 2 to a Public Conservation and Resource Zone and applies the Environmental Significance Overlay Schedule 25 (ESO25) to 520A Arthurs Seat Road, Red Hill, and an Incorporated Document through the use of the Schedules to Clauses 52.03 and 81.01; and
- removes part of the Heritage Overlay from 2A Erlandsen Avenue, Sorrento.

A copy of the Amendment can be inspected, free of charge, at the Department of Environment, Land, Water and Planning website at [www.delwp.vic.gov.au/public-inspection](http://www.delwp.vic.gov.au/public-inspection) and free of charge, during office hours, at the offices of the Mornington Peninsula Shire Council, Hastings Office, 21 Marine Parade, Hastings; Mornington Office, 2 Queen Street, Mornington; and Rosebud Office, 90 Besgrove Street, Rosebud.

JIM GARDNER  
Executive Director  
Statutory Planning and Heritage  
Department of Environment, Land, Water and Planning

**Planning and Environment Act 1987**  
SOUTH GIPPSLAND PLANNING SCHEME  
Notice of Approval of Amendment  
Amendment C52 (Part 2)

The Minister for Planning has approved Amendment C52 (Part 2) to the South Gippsland Planning Scheme.

The Amendment comes into operation on the date this notice is published in the Government Gazette.

The Amendment rezones land fronting the south-east side of Jumbunna Road, Korumburra, from the Farming Zone to the General Residential Zone Schedule 1, applies the Development Plan Overlay Schedule 7 to the land and deletes the Environmental Significance Overlay Schedule 5 from the land. The Amendment also rezones Lot 1 TP868143 from the Farming Zone to the Public Use Zone 2 (Education).

A copy of the Amendment can be inspected, free of charge, at the Department of Environment, Land, Water and Planning website at [www.delwp.vic.gov.au/public-inspection](http://www.delwp.vic.gov.au/public-inspection) and free of charge, during office hours, at the offices of the South Gippsland Shire Council, 9 Smith Street, Leongatha.

JIM GARDNER  
Executive Director  
Statutory Planning and Heritage  
Department of Environment, Land, Water and Planning

**Planning and Environment Act 1987**  
**SOUTH GIPPSLAND PLANNING SCHEME**  
 Notice of Approval of Amendment  
 Amendment C96

The Minister for Planning has approved Amendment C96 to the South Gippsland Planning Scheme.

The Amendment comes into operation on the date this notice is published in the Government Gazette.

The Amendment rezones land at 65 Korumburra–Wonthaggi Road, Korumburra, from Farming Zone to General Residential Zone Schedule 1, removes the Environmental Significance Overlay Schedule 5 from the land being rezoned, and introduces and applies Schedule 8 to the Development Plan Overlay to land being rezoned and to 35 Korumburra–Wonthaggi Road.

A copy of the Amendment can be inspected, free of charge, at the Department of Environment, Land, Water and Planning website at [www.delwp.vic.gov.au/public-inspection](http://www.delwp.vic.gov.au/public-inspection) and free of charge, during office hours, at the offices of the South Gippsland Shire Council, 9 Smith Street, Leongatha.

JIM GARDNER  
 Executive Director  
 Statutory Planning and Heritage  
 Department of Environment, Land, Water and Planning

**Planning and Environment Act 1987**  
**SOUTHERN GRAMPPIANS PLANNING SCHEME**  
 Notice of Approval of Amendment  
 Amendment C28

The Minister for Planning has approved Amendment C28 to the Southern Grampians Planning Scheme.

The Amendment comes into operation on the date this notice is published in the Government Gazette.

The Amendment rezones part of the land at 1068 Hensley Park Road, Hensley Park, and 986 Hensley Park Road, Hensley Park, from Farming Zone to Special Use Zone Schedule 6 – Hamilton Airport and corrects a schedule numbering error.

The Minister has granted the following permit under Division Five Part Four of the Act:

Permit No.	Description of land
TP/034/2014	Part 1068 Hensely Park Road, Hensley Park and Part 986 Hensely Park Road, Hensley Park

A copy of the Amendment can be inspected, free of charge, at the Department of Environment, Land, Water and Planning website at [www.delwp.vic.gov.au/public-inspection](http://www.delwp.vic.gov.au/public-inspection) and free of charge, during office hours, at the offices of the Southern Grampians Shire Council, 1 Market Place, Hamilton, Victoria 3300.

JIM GARDNER  
 Executive Director  
 Statutory Planning and Heritage  
 Department of Environment, Land, Water and Planning

**Planning and Environment Act 1987**  
**STRATHBOGIE PLANNING SCHEME**  
Notice of Approval of Amendment  
Amendment C42

The Minister for Planning has approved Amendment C42 to the Strathbogie Planning Scheme. The Amendment comes into operation on the date this notice is published in the Government Gazette.

The Amendment rezones land at Murray Street, Nagambie, from Farming Zone to General Residential Zone.

A copy of the Amendment can be inspected, free of charge, at the Department of Environment, Land, Water and Planning website at [www.delwp.vic.gov.au/public-inspection](http://www.delwp.vic.gov.au/public-inspection) and free of charge, during office hours, at the offices of the Strathbogie Shire Council, 109A Binney Street, Euroa.

JIM GARDNER  
Executive Director  
Statutory Planning and Heritage  
Department of Environment, Land, Water and Planning

---

**Planning and Environment Act 1987**  
**WYNDHAM PLANNING SCHEME**  
Notice of Approval of Amendment  
Amendment C213

The Minister for Planning has approved Amendment C213 to the Wyndham Planning Scheme. The Amendment comes into operation on the date this notice is published in the Government Gazette.

The Amendment applies the Road Zone Category 2 to Leakes Road, Truganina, between Marquands Road and Palmer Road within the Urban Growth Zone Schedule 1 (UGZ1) in order to accurately reflect the intended land use, the road hierarchy and improve the operation of the planning scheme.

A copy of the Amendment can be inspected, free of charge, at the Department of Environment, Land, Water and Planning website at [www.delwp.vic.gov.au/public-inspection](http://www.delwp.vic.gov.au/public-inspection) and free of charge, during office hours, at the offices of the Wyndham City Council, 45 Princes Highway, Werribee, Victoria.

JIM GARDNER  
Executive Director  
Statutory Planning and Heritage  
Department of Environment, Land, Water and Planning

---

**Planning and Environment Act 1987**

GLEN EIRA PLANNING SCHEME

Notice of Lapsing of Amendment

Amendment C100 (Part 2)

The Glen Eira City Council has resolved to abandon Amendment C100 (Part 2) to the Glen Eira Planning Scheme.

The Amendment C100(Part 2) proposed to rezone 2–4 Emily Street and 394–412 Neerim Road, Murrumbeena, from Industrial 3 Zone to Mixed Use Zone and apply the Environmental Audit Overlay over both sites.

The Amendment C100 (Part 2) lapsed on the 26 February 2013.

JIM GARDNER  
Executive Director  
Statutory Planning and Heritage  
Department of Environment, Land, Water and Planning

---

**Planning and Environment Act 1987**

MORNINGTON PENINSULA SCHEME

Notice of Lapsing of Amendment

Amendment C126 (Part 3)

The Mornington Peninsula Shire Council has resolved to abandon Amendment C126 (Part 3) to the Mornington Peninsula Planning Scheme.

The Amendment C126 (Part 3) proposed to rezone two parcels of land at 3053 Frankston–Flinders Road and 8 Civic Court, Balnarring, from a Public Use Zone 6 (PUZ6) to a Business 5 Zone (B5Z) and a Residential 1 Zone (R1Z) retrospectively.

The Amendment C126 (Part 3) lapsed on the 27 October 2014.

JIM GARDNER  
Executive Director  
Statutory Planning and Heritage  
Department of Environment, Land, Water and Planning

---

**Planning and Environment Act 1987**

STONNINGTON PLANNING SCHEME

Notice of Lapsing of Amendment

Amendment C180

Stonnington City Council has resolved to abandon Amendment C180 to the Stonnington Planning Scheme.

Amendment C180 proposed to apply a Public Acquisition Overlay (Schedule 3) to the land at 37 and 39 Carters Avenue, Toorak, to extend Carters Avenue Reserve, Toorak.

Amendment C180 lapsed on the 2 February 2015.

JIM GARDNER  
Executive Director  
Statutory Planning and Heritage  
Department of Environment, Land, Water and Planning

---



**ORDERS IN COUNCIL**

**Crown Land (Reserves) Act 1978**  
**RESERVATION OF CROWN LAND**  
**FOR COURT PURPOSES**

Order in Council

The Governor in Council under section 4(1) of the **Crown Land (Reserves) Act 1978** temporarily reserves the following Crown lands which in his opinion are required for Public purposes (Court purposes):

**MUNICIPAL DISTRICT OF THE**  
**PORT PHILLIP CITY COUNCIL**

**PRAHRAN** – Public purposes (Court purposes); area 493 square metres, being Crown Allotment 71E, Parish of Prahran as shown on Plan No. CP113168 lodged in the Central Plan Office of the Department of Environment, Land, Water and Planning. – (P243783)

**MUNICIPAL DISTRICT OF THE**  
**CITY OF MELBOURNE**

**MELBOURNE** – Public purposes (Court purposes); area 2949 square metres, being Crown Allotment 22E, City of Melbourne, Parish of Melbourne North as shown on Plan No. OP120651 lodged in the Central Plan Office of the Department of Environment, Land, Water and Planning. – (P361423)

**MELBOURNE** – Public purposes (Court purposes); being Crown Allotment 2091, City of Melbourne, Parish of Melbourne North, area 13.2 square metres, as shown on Plan No. OP123659 hereunder. – (OP123659) – (Rs 37135)



**OP123659**

**MUNICIPAL DISTRICT OF THE MOUNT**  
**ALEXANDER SHIRE COUNCIL**  
**CASTLEMAINE** – Public purposes (Court purposes); area 1699 square metres, being Crown Allotment 1, Section 14, Township of Castlemaine, Parish of Castlemaine as shown on Plan No. OP123655 hereunder. – (OP123655) – (P134134)

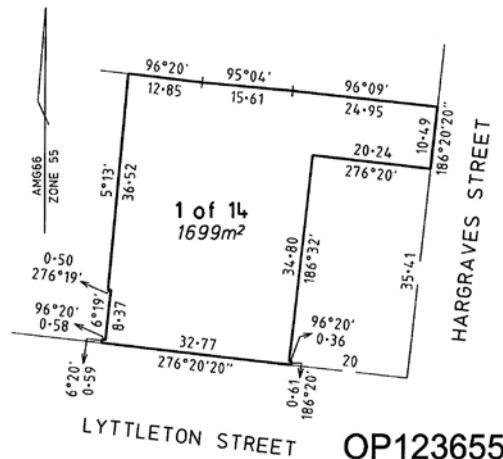

**OP123655**

**MUNICIPAL DISTRICT OF THE**  
**MOIRA SHIRE COUNCIL**

**COBRAM** – Public purposes (Court purposes); area 981 square metres, being Crown Allotment 2016, Parish of Cobram as shown on Plan No. OP123656 hereunder. – (OP123656) – (P388447)

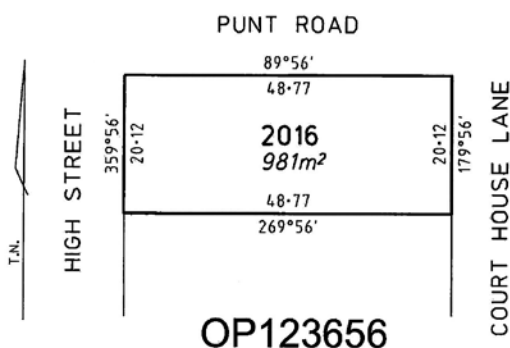

**OP123656**

**MUNICIPAL DISTRICT OF THE**  
**DAREBIN CITY COUNCIL**

**JIKA JIKA** – Public purposes (Court purposes); area 997 square metres, being Crown Allotment 2002, Parish of Jika Jika as shown on Plan No. OP121532 lodged in the Central Plan Office of the Department of Environment, Land, Water and Planning. – (P369447)

## MUNICIPAL DISTRICT OF THE GANNAWARRA SHIRE COUNCIL

KERANG – Public purposes (Court purposes); area 1055 square metres, being Crown Allotment 2014, Township of Kerang, Parish of Kerang as shown on Plan No. OP123547 lodged in the Central Plan Office of the Department of Environment, Land, Water and Planning. – (06L5-0571)

This Legislative Instrument is effective from the date on which it is published in the Government Gazette.

Dated 14 April 2015

Responsible Minister

HON LISA NEVILLE MP

Minister for Environment,  
Climate Change and Water

YVETTE CARISBROOKE  
Clerk of the Executive Council

**Local Government Act 1989**

ORDER ALTERING THE BOUNDARIES OF HUME CITY COUNCIL  
AND CONSTITUTING A NEW CITY COUNCIL BY THE NAME OF  
SUNBURY CITY COUNCIL

Order in Council

The Governor in Council under sections 220Q, 220R and 220S of the **Local Government Act 1989** makes an Order to –

- (a) revoke the Order in Council altering the boundaries of Hume City Council and constituting a new city council by the name of Sunbury City Council, made on 29 October 2014 and published on the 30 October 2014 in the Victoria Government Gazette G44;
- (b) alter the boundaries of the municipal district of Hume City Council on 1 July 2016, as specified in clause 4 of the Order;
- (c) constitute on 1 July 2016 a new City Council by the name of Sunbury City Council with fixed municipal district boundaries as specified in clause 12 of the Order;
- (d) provide transitional arrangements in relation to the new Sunbury City Council;
- (e) appoint Joanne Mavis Anderson as the Administrator to Sunbury City Council, from 1 July 2016 until the first election of the Council in October 2016; and
- (f) appoint Vince Haining as the interim Chief Executive Officer to Sunbury City Council, from 1 July 2016 until such time the Council appoints a new Chief Executive Officer.

The details of the Order are contained in the attached schedules.

Dated 14 April 2015

Responsible Minister:

NATALIE HUTCHINS MP

Minister for Local Government

YVETTE CARISBROOKE  
Clerk of the Executive Council

**Local Government Act 1989**

ORDER ALTERING THE BOUNDARIES OF HUME CITY COUNCIL  
AND CONSTITUTING A NEW CITY COUNCIL BY THE NAME OF  
SUNBURY CITY COUNCIL

**SCHEDULE 1 TO THE ORDER IN COUNCIL**

**PART 1 – PRELIMINARY**

**1. Definitions**

*Act* means the **Local Government Act 1989**;

*Administrator* means a person appointed by the Governor in Council under section 220R of the Act to administer Sunbury City Council;

**appointed day** means the day on which this Order comes into operation;

**CEO** means the interim Chief Executive Officer of Sunbury City Council appointed in accordance with Schedule 2;

**constitution day** means 1 July 2016;

**corporate services** means operating systems, including information technology systems;

**delegate** means a member of the relevant council staff delegated by instrument of delegation any power, duty or function of the relevant Council under the Act or any other Act;

**establishment costs** means the costs directly associated with establishment of Sunbury City Council, including any associated capital costs;

**fixed area** means the fixed area specified under clause 11;

**immovable assets** means real property or any physical asset that is permanently attached to real property;

**instrument** includes contract and agreement;

**intangible and movable assets** means any asset that is not an immovable asset;

**period of administration** means the period the Administrator is appointed to administer Sunbury City Council under clause 13 of Schedule 3;

**relevant Council** means Hume City Council or Sunbury City Council, as the context requires;

**Transition Plan** means a plan outlining the arrangements for the establishment, and effective operation and function of Sunbury City Council.

## **PART 2 – COMMENCEMENT**

2. This Order comes into operation on the day on which the Order is published in the Victoria Government Gazette.

## **PART 3 – REVOCATION**

3. The Order altering the boundaries of Hume City Council and constituting a new city council by the name of Sunbury City Council, made on 29 October 2014 and published in the Victoria Government Gazette G44 on 30 October 2014, is revoked.

## **PART 4 – HUME CITY COUNCIL**

### **Boundaries**

4. On the constitution day, the boundaries of the municipal district of Hume City Council are altered and fixed as described in plan LEGL./15-251 lodged in the Central Plan Office.

### **Qualification of Councillors**

5. From the constitution day and until the next general election for Hume City Council, a councillor of Hume City Council is not disqualified from continuing in office only because he or she ceases to have an entitlement to be enrolled on Hume City Council's voters' roll as a result of this Order.

## **PART 5 – CONSTITUTION OF SUNBURY CITY COUNCIL**

### **Constitution of Sunbury City Council**

6. On the constitution day, there is constituted a body corporate constituted as a new City Council by the name of Sunbury City Council.

### **Administration**

7. The provisions of Schedule 2 apply to the CEO of Sunbury City Council.
8. The CEO must call the first meeting of Sunbury City Council which must be held within 3 days of the constitution day.
9. Section 89(4) of the Act does not apply to the first meeting of Sunbury City Council.
10. The provisions of Schedule 3 apply to the Administrator and meetings of the Administrator.

### **Boundaries**

11. On the constitution day, the boundaries of the municipal district of Sunbury City Council are fixed as described in plan LEGL./15-250 lodged in the Central Plan Office.

**Holding of first election**

12. The first general election of councillors for Sunbury City Council is to be held under section 31(1) of the Act on the fourth Saturday in October 2016.

**PART 6 – GENERAL****Transfer of immovable assets**

13. On the constitution day, the estate and interest of Hume City Council in all immovable assets in the fixed area vests in Sunbury City Council.
14. The Registrar of Titles, on being requested to do so and on delivery of any relevant certificates of title or instruments relating to land affected by clause 13, must make any amendments in the Register that are necessary as a result of the operation of clause 13.

**Transfer of liabilities and intangible and movable assets**

15. Within three months after the constitution day, an audit of all liabilities and intangible and moveable assets, held by Hume City Council as at 30 June 2016 must be conducted by Hume City Council and the monetary value of those assets and liabilities as at 30 June 2016 calculated for the purposes of clause 16.
16. After the constitution day and before 31 December 2016, a sum of money equal to 23.6% of the net value of Hume City Council's liabilities and intangible and movable assets, calculated under clause 15, must be paid by Hume City Council to Sunbury City Council.
17. Notwithstanding clause 16, Hume City Council and Sunbury City Council may, by agreement or understanding, transfer or assign any intangible and movable assets to Sunbury City Council in lieu of part or all of the money required to be paid under clause 16.

**Audit of transfer of assets and liabilities**

18. Within 12 months after the constitution day, or such other time as is agreed by both Sunbury City Council and Hume City Council, a person or body will be jointly appointed by each relevant Council to conduct an audit of the apportionment, settlement, transfer, adjustment or determination of assets and liabilities, as required under this Order, where such auditor is to provide, in writing, an opinion on the fairness of the final result to each relevant Council.

**Staff**

19. For the purposes of clause 20, no later than 90 days before the constitution day Hume City Council must identify those employees of Hume City Council equal to 23.6% of full time equivalent Hume City Council staff as at 30 June 2016 who are to transfer to Sunbury City Council on the constitution day.
20. On the constitution day, the Hume City Council staff identified under clause 19 become employees of Sunbury City Council on the same terms and conditions of employment, including any benefit of accrued rights and entitlements, as they enjoyed on the day immediately prior to the transfer.

**Rights, entitlements, obligations and liabilities**

21. On the constitution day, all rights, entitlements, obligations and liabilities, including any inchoate rights, entitlements, obligations and liabilities of Hume City Council existing immediately prior to the constitution day in relation to or in connection with the fixed area are deemed to be the rights, entitlements, obligations and liabilities of Sunbury City Council.

**Enforcement and Proceedings**

22. Without limiting clause 21, where, immediately prior to the constitution day, proceedings relating to the fixed area to which Hume City Council is a party are pending or existing in any court or tribunal, then except as otherwise provided in this Order, from the constitution day, Sunbury City Council is substituted for Hume City Council as a party to the proceedings and has the same rights in the proceedings as Hume City Council had.

**References**

23. From the constitution day, to the extent it is applicable to the fixed area, any reference in any instrument or any other document of any kind to Hume City Council is to be construed as a reference to Sunbury City Council, unless the contrary intention appears in this Order.

**Local laws and other matters**

24. From the constitution day –
- 24.1 Hume City Council's local laws in force in relation to the fixed area immediately prior to the constitution day, will operate as if those local laws were made by Sunbury City Council, unless and until amended or revoked by Sunbury City Council.
- 24.2 From the constitution day, authorised officers appointed by Hume City Council under the Act shall be responsible for the enforcement of local laws within Sunbury City Council's municipal district until such time an agreement is reached between the Councils for the transfer of this function to Sunbury City Council
25. From the constitution day, authorised officers of Hume City Council under the Act or any other Act shall continue to be authorised to administer and enforce that legislation in the fixed area until such time as arrangements are made for the transfer of this function to Sunbury City Council.

**PART 7 – TRANSITIONAL PROVISIONS****Transition Plan**

26. Hume City Council must prepare a Transition Plan by 1 January 2016.

**Statutory reporting – transitional provisions**

27. Prior to the constitution day, Hume City Council must prepare and adopt a budget for the 2016-17 financial year as if the municipal district of Hume City Council excludes the fixed area.
28. Prior to the constitution day, Hume City Council must prepare and adopt a budget for the 2016-17 financial year for the fixed area as if the fixed area were a municipal district governed by Sunbury City Council.
29. The budget under clause 28 must include establishment costs.
30. Prior to the constitution day, Hume City Council must, in respect of the 2016-17 financial year, declare the amount to be raised by rates and charges in relation to the Sunbury City Council for the purpose of clause 28.
31. From the constitution day, a decision of Hume City Council made under clause 28 is deemed to be a decision of Sunbury City Council for the purposes of the Act.
32. Hume City Council may charge Sunbury City Council a reasonable and competitive rate for the actions performed in accordance with clauses 28 and 30, and for all actions performed to create the operating systems for Sunbury City Council, with the total amount chargeable to be no more than \$1,000,000.

**Functions and duties – transitional provisions**

33. From the appointed day until the constitution day Hume City Council will continue to perform the functions and duties and exercise the powers conferred under the Act or any other Act in relation to the fixed area as provided by it immediately prior to the appointed day.

**Council Plan and other plans – transitional provisions**

34. From the appointed day –
- 34.1. the Council Plan and the Strategic Resources Plan prepared and adopted by Hume City Council will continue to apply in relation to the fixed area as they applied immediately prior to the appointed day until the Sunbury City Council prepares and adopts a Council Plan and a Strategic Resources Plan, which must be no later than 30 June 2017; and

- 34.2. any other plans prepared and adopted by Hume City Council will continue to apply in relation to the fixed area as they applied immediately prior to the appointed day until such time that any such other plans are amended or revoked by Sunbury City Council.

#### **Municipal services – transitional provisions**

35. From the constitution day, Hume City Council shall provide corporate services within the fixed area in accordance with Sunbury City Council's budget for the 2016-17 financial year, until 30 June 2017 or until such other time an agreement is reached between the Hume City Council and Sunbury City Council to continue or discontinue Hume City Council's delivery of a service.
36. Hume City Council must charge a reasonable and competitive rate for the provision of the corporate services under clause 35.

#### **Transfer of immovable assets – transitional provisions**

37. Hume City Council must identify and produce an inventory of all immovable assets and immovable liabilities held by Hume City Council within the fixed area immediately prior to the appointed day, and provide such inventory to Sunbury City Council on the constitution day.
38. From the appointed day until the constitution day, Hume City Council must not transfer or sell any immovable assets within the fixed area, except insofar as the transfer or sale relates to an obligation of Hume City Council that existed immediately prior to the appointed day.

#### **Special financial transaction – transitional provision**

39. From the constitution day to 30 June 2025 inclusive, Hume City Council is to pay to Sunbury City Council in instalments each financial year, a sum equal to the lesser of \$2,470,000 or 23.6% of the financial benefit received in the preceding financial year by Hume City Council from Australia Pacific Airports (Melbourne) Pty Ltd ACN 076 999 114 (APAM), in accordance with the Memorandum of Understanding between Hume City Council and APAM dated 13 August, 2008 as amended or replaced from time to time.

#### **Planning – transitional provisions**

40. Subject to this clause and notwithstanding anything to the contrary in the **Planning and Environment Act 1987** –
- 40.1. the planning scheme that applies in relation to the fixed area immediately before the date of constitution, continues to have the same operation and effect from the date of constitution as if the fixed area had not been severed from the municipal district of the Hume City Council, and until such time the planning scheme is amended or revoked;
- 40.2. no act, manner or thing under that planning scheme or the **Planning and Environment Act 1987** is in any way abated or affected by reason of the fixed area being so severed or any act, manner or thing may be continued and concluded in all respects as if the area had not been severed.
41. Except where the planning scheme specifies the Minister administering the **Planning and Environment Act 1987** or any other person to be the responsible authority, the Hume City Council is the responsible authority for the purposes of the **Planning and Environment Act 1987** in relation to the planning scheme referred to in subclause 40.1.
42. For the purposes of the **Planning and Environment Act 1987** and the administration, amendment or enforcement of the planning scheme referred to in subclause 39.1 –
- 42.1. anything of a continuing nature (including a contract, agreement or proceeding) done, commenced or made by or in relation to the Hume City Council in relation to the fixed area may be done, enforced or completed by or in relation to the Sunbury City Council upon agreement or understanding by both Councils;
- 42.2. anything done by or in relation to the Hume City Council that concerns a matter of a continuing nature in relation to the fixed area has effect as if done by or in relation to the Sunbury City Council.

**Delegations – transitional provisions**

43. A delegate of the Hume City Council immediately prior to the constitution day, is also a delegate of the Sunbury City Council from the constitution day and may perform their delegated duties or functions and exercise their delegated powers in relation to the Sunbury City Council insofar as those powers, duties or functions are applicable to the municipal district of the Sunbury City Council, and until otherwise determined by Sunbury City Council.
44. From the constitution day and until 30 June 2017, Sunbury City Council or the Chief Executive Officer of Sunbury City Council may, with the agreement of Hume City Council, delegate any power, duty or function in accordance with the Act to a member of Hume City Council staff in respect of the period commencing on the constitution day, until that delegation is otherwise amended or revoked by Sunbury City Council or the Chief Executive Officer of Sunbury City Council.
45. A member of Hume City Council staff delegated any power, duty or function under clause 44 may only perform those delegated duties or functions and exercise those delegated powers in relation to the Sunbury City Council insofar as those powers, duties or functions are applicable to the municipal district of the Sunbury City Council, for that period specified in accordance with clause 44.

**PART 8 – BEST INTERESTS**

46. All matters to be performed or exercised by Hume City Council under this Order must be performed and exercised in the best interests of the local community in the municipal district of the Hume City Council and the fixed area.

**PART 9 – DISPUTE RESOLUTION**

47. If a dispute occurs between Sunbury City Council and Hume City Council in connection with this Order, the following dispute resolution procedure must be followed:
  - 47.1. The Council claiming that a dispute has arisen (**Complainant**), must give written notice to the other Council to the dispute (**Respondent**) specifying:
    - 47.1.1. the nature of the dispute;
    - 47.1.2. what outcome the Complainant wants; and
    - 47.1.3. what action the Complainant considers will settle the dispute.
  - 47.2. upon the Respondent receiving the notice, the Respondent and the Complainant must endeavour in good faith to resolve the dispute.
  - 47.3. if the dispute is not resolved within 21 days after the Respondent receives the notice (or within such further period as the Respondent and the Complainant may agree), either the Respondent or the Complainant may request in writing the Minister for Local Government to refer the dispute to the Governor in Council under section 9 of the Act.

**SCHEDULE 2 TO THE ORDER IN COUNCIL**

1. The Governor in Council, under section 220R of the Act, appoints Vince Haining as the CEO.
2. The person specified under clause 1 of Schedule 2 is appointed as CEO from 6.00 am on the constitution day until such time as Sunbury City Council appoints a Chief Executive Officer in accordance with Part 4 of the Act.
3. The CEO is entitled to receive –
  - (a) an annual remuneration;
  - (b) any travelling allowance or subsistence allowances, including, if required, accommodation expenses; and
  - (c) any other allowances in relation to expenses incurred in the discharge of his or her duties –that the Minister may from time to time determine in respect of the CEO.

4. Such remuneration, allowances and expenses are to be paid by Sunbury City Council.
5. The CEO must during the period of administration ensure that the operations of Sunbury City Council are carried out in the most efficient and economic manner possible and in accordance with the Act.
6. The person specified under clause 1 of Schedule 2 is the person authorised to exercise the powers and perform the duties and functions conferred or imposed on Chief Executive Officers by law including by this or any other Order, the Act and any other Act until that person ceases to be the CEO.

### **SCHEDULE 3 TO THE ORDER IN COUNCIL**

1. The Governor in Council, under sections 220Q and 220R of the Act, appoints Joanne Mavis Anderson as an Administrator.
2. The Administrator is entitled to receive –
  - (a) an annual remuneration;
  - (b) any travelling allowance or subsistence allowances, including accommodation expenses; and
  - (c) any other allowances in relation to reasonable expenses incurred in the discharge of his or her duties –
 

that the Minister may from time to time determine in respect of the Administrator.
3. Such remuneration, allowances and expenses are to be paid by Sunbury City Council.
4. The Administrator must during the period of administration –
  - (a) ensure that the operations of Sunbury City Council are carried out in the most efficient and economic manner possible;
  - (b) report to the Minister on such matters and at such intervals as the Minister may specify.
5. The Administrator –
  - (a) must not, without the consent of the Minister, while in office directly or indirectly engage in any paid employment outside the duties of his or her office;
  - (b) may resign the office in writing signed by him or her and delivered to the Governor in Council;
  - (c) may at any time be removed from office by the Governor in Council.
6. If the Administrator –
  - (a) becomes bankrupt or his or her property becomes in any manner subject to control under the law relating to bankruptcy;
  - (b) is convicted of an indictable offence or of an offence which, if committed in Victoria, would be an indictable offence;
  - (c) becomes incapable of performing the duties of office;
  - (d) is removed from office or resigns the office; or
  - (e) dies –
 

the office of the Administrator becomes vacant.
7. During the absence from office or illness of the Administrator, a person nominated by the Minister shall act in the place of the Administrator and while so acting shall have, exercise and discharge all the responsibilities, liabilities, rights, powers, authorities, duties and functions conferred or imposed on the Administrator by or under this Order.
8. An act or decision of the Administrator is not invalid by reason only of a defect or irregularity in or in connection with the appointment of an Administrator or that Administrator, as the case may be.



9. No person shall be concerned to inquire whether any occasion had arisen requiring or authorising a person to act in the place of the Administrator and all acts or things done or omitted to be done by the person, while so acting, shall be as valid and effectual and shall have the same consequence as if the acts or things had been done or omitted to be done by the Administrator.
10. Where provision is made in any Act, regulation, rule, local law, instrument or document –
- for the Mayor, a Councillor or a member of a committee of Sunbury City Council, to be a member of or to be represented on a board, Council, committee, commission or other body, or to be a trustee, or to be a member or director of a company, that provision has effect during the period of administration as if it provided for the Administrator or some other person appointed by the Administrator to be that member, representative, trustee or director.
  - for a Council to appoint a Councillor to be the representative of the Council that provision has effect during the period of administration as if it provided for the Administrator or some other person nominated by the Administrator to be the representative; or
  - for a member of a board, Council, committee, commission or other body to be appointed from a panel of Councillors of municipal Councils, that provision has effect during the period of administration as if it provided for the Administrator or some other person nominated by an Administrator to be included in the panel.
11. Sections 71, 74, 74B and 75 of the Act do not apply to the Administrator.
12. Except as provided for in this Order the procedure for meetings of Sunbury City Council may be determined by the Administrator.
13. The person specified under clause 1 of Schedule 3 is appointed to administer the Sunbury City Council from 6.00 am on the constitution day until 9.00 am on the day on which the first meeting of Sunbury City Council is held following the first election of Councillors under clause 12 of this Order.

### Road Management Act 2004

#### ORDER PURSUANT TO CLAUSE 27 AND 28 OF SCHEDULE 5A

##### Order in Council

The Governor in Council, under clause 27 of Schedule 5A to the **Road Management Act 2004**, declares that all interests in the land located in the Redevelopment Project area and as identified in the Schedule to this Order are surrendered to the Crown.

This Order comes into effect from the date it is published in the Government Gazette.

Dated 14 April 2015

Responsible Minister:

LUKE DONNELLAN MP

Minister for Roads and Road Safety

YVETTE CARISBROOK  
Clerk of the Executive Council

#### SCHEDULE

Item	Authorising Provision	Land Description
1	Clause 27 of Schedule 5A of the <b>Road Management Act 2004</b> (unreserved Crown land)	Parcels 16E, 16H, 16J and 16K on Roads Corporation survey plan SP21427C.
		Parcels 15F, 15H, 15J, 15K and 15L on Roads Corporation survey plan SP21463B.

**State Owned Enterprises Act 1992**  
**Rural Finance Act 1988**

CHANGES TO THE CONSTITUTION OF THE BOARD OF  
RURAL FINANCE CORPORATION OF VICTORIA

Order in Council

The Rural Finance Corporation of Victoria, being a statutory corporation established under the **Rural Finance Act 1988**, has been declared to be a reorganising body for the purposes of the **State Owned Enterprises Act 1992**.

The Governor in Council:

- under section 8(2)(a) of the **State Owned Enterprises Act 1992** changes the number of members of the Board of the Rural Finance Corporation of Victoria from not less than five to three members from the date of this Order;
- under section 8(2)(d) of the **State Owned Enterprises Act 1992** removes the requirement for the Chief Executive Officer to reside on the Board of Rural Finance Corporation of Victoria from the date of this Order;
- under section 8(2)(d) of the **State Owned Enterprises Act 1992** removes the requirement for the appointment of a Deputy Chairperson on the Board of Rural Finance Corporation of Victoria from the date of this Order;
- under section 8(4) of the **State Owned Enterprises Act 1992** removes Ms Sonia Petering as a member and Chairperson and removes Mr William Whitford as a member of the Board of the Rural Finance Corporation of Victoria from the date of this Order; and
- under sections 8(2)(b) and 8(3) of the **State Owned Enterprises Act 1992** appoints Ms Sonia Petering as member and Chairperson and Mr William Whitford and Mr Joe Bonnici as members of the Board of Rural Finance Corporation of Victoria on terms and conditions set out in the Schedule to this Order from the day after this Order is made until 30 June 2017.

Dated 14 April 2015

Responsible Minister:

TIM PALLAS MP

Treasurer

YVETTE CARISBROOKE  
Clerk of the Executive Council

**State Owned Enterprises Act 1992**  
**Rural Finance Act 1988**

CHANGES TO THE CONSTITUTION OF THE BOARD OF  
RURAL FINANCE CORPORATION OF VICTORIA

SCHEDULE TO THE ORDER IN COUNCIL

1. **Appointment Arrangements**  
The appointments are part-time.
2. **Period of Appointment**  
The appointments of Ms Petering, Mr Whitford and Mr Bonnici on the Board of Rural Finance Corporation of Victoria (RFCV) are from the day after this Order is made until 30 June 2017.
3. **Duties and responsibilities of the position**  
RFCV is obliged under the **Rural Finance Act 1988** to perform certain non-commercial services such as administration of Commonwealth and Victorian Government initiatives which are intended to assist, promote and develop rural industries and regional communities in Victoria. RFCV's statutory obligations to perform these non-commercial functions are not affected by the sale of RFCV's commercial business and assets.

**4. Termination Arrangements**

The Governor in Council may remove members of the Board of a reorganising body under section 8(4) of the **State Owned Enterprises Act 1992**.

**5. Payment Provisions**

Ms Petering will be remunerated at a rate of \$38,086 per annum.

Mr Whitford and Mr Bonnici are full-time employees in the Victorian public sector and will not be entitled to additional remuneration for this role.

**6. Superannuation Obligations**

Superannuation contributions will be paid by the employer in accordance with the Commonwealth's **Superannuation Guarantee Act 1992**.

**7. Travel and Personal Expenses arrangements**

Travel and personal expenses reasonably incurred in the discharge of office will be reimbursed by RFCV.

**8. Leave Arrangements**

Not applicable.

**9. Prior Service**

Not applicable.

---

This page was left blank intentionally

This page was left blank intentionally

This page was left blank intentionally

### PRICING FOR SPECIAL GAZETTE, PERIODICAL GAZETTE AND VICTORIAN LEGISLATION

Retail price varies according to the number of pages in each Victoria Government Special Gazette, Victoria Government Periodical Gazette and Victorian legislation. The table below sets out the prices that apply.

<i>Price Code</i>	<i>No. of Pages (Including cover and blank pages)</i>	<i>Price*</i>	<i>Price Code</i>	<i>No. of Pages (Including cover and blank pages)</i>	<i>Price*</i>
A	1–16	\$4.00	#Z	1407–1470	\$119.05
B	17–32	\$6.00	#ZA	1471–1536	\$124.70
C	33–48	\$8.20	#ZB	1537–1610	\$129.45
D	49–96	\$12.90	#ZC	1611–1666	\$134.90
E	97–144	\$16.60	#ZD	1667–1730	\$140.00
F	145–192	\$19.70	#ZE	1731–1796	\$145.65
G	193–240	\$22.70	#ZF	1797–1860	\$150.90
H	241–288	\$24.10	#ZG	1861–1926	\$155.85
I	289–352	\$27.20	#ZH	1927–1990	\$161.50
J	353–416	\$31.70	#ZI	1991–2056	\$166.60
K	417–480	\$36.20			
L	481–544	\$42.20			
M	545–608	\$48.25			
N	609–672	\$53.35			
O	673–736	\$60.30			
P	737–820	\$66.45			
#Q	821–886	\$72.25			
#R	887–950	\$77.05			
#S	951–1016	\$82.30			
#T	1017–1080	\$87.40			
#U	1081–1146	\$92.65			
#V	1147–1210	\$98.10			
#W	1211–1276	\$103.20			
#X	1277–1340	\$108.80			
#Y	1341–1406	\$113.70			

\* All prices include GST

# Printed as two volumes

**bluestar**  **PRINT**

The *Victoria Government Gazette* is published by Blue Star Print with the authority of the Government Printer for the State of Victoria

© State of Victoria 2015

This publication is copyright. No part may be reproduced by any process except in accordance with the provisions of the Copyright Act.

Address all enquiries to the Government Printer for the State of Victoria

Level 2, 1 Macarthur Street  
Melbourne 3002  
Victoria Australia

**How To Order****Retail &  
Mail Sales**

**Victoria Government Gazette**  
Level 5, 460 Bourke Street  
Melbourne 3000

PO Box 1957 Melbourne 3001

DX 106 Melbourne

**Telephone**

(03) 8523 4601

**Fax**

(03) 9600 0478

**email**

gazette@bluestargroup.com.au

**Recommended Retail Price \$2.10 (includes GST)**